

Alienware m17 R4 Service Manual

Notes, cautions, and warnings

 **NOTE:** A NOTE indicates important information that helps you make better use of your product.

 **CAUTION:** A CAUTION indicates either potential damage to hardware or loss of data and tells you how to avoid the problem.

 **WARNING:** A WARNING indicates a potential for property damage, personal injury, or death.

Contents

Chapter 1: Working inside your computer	6
Safety instructions	6
Working inside your computer	6
After working inside your computer	8
Chapter 2: Removing and installing components	9
Recommended tools	9
Screw list	9
Major components of Alienware m17 R4	10
Base cover	12
Removing the base cover	12
Installing the base cover	14
Solid state drive—M.2 slot one	16
Removing the 2280 solid-state drive from the M.2 slot one	16
Installing the 2280 solid-state drive from the M.2 slot one	17
Removing the 2230 solid-state drive from the M.2 slot one	18
Installing the M.2 2230 solid-state drive from the M.2 slot one	19
Solid state drive—M.2 slot two	21
Removing the 2280 solid-state drive from the M.2 slot two	21
Installing the 2280 solid-state drive from the M.2 slot two	22
Removing the 2230 solid-state drive from the M.2 slot two	23
Installing the 2230 solid-state drive from the M.2 slot two	24
Solid state drive—M.2 slot three	26
Removing the 2230 solid-state drive from the M.2 slot three	26
Installing the 2230 solid-state drive from the M.2 slot three	26
Battery	27
Lithium-ion battery precautions	27
Removing the battery	28
Installing the battery	29
Speakers	30
Removing the speakers	30
Installing the speakers	30
Keyboard-controller board	31
Removing the keyboard-controller board	31
Installing the keyboard-controller board	32
Touchpad	33
Removing the touchpad	33
Installing the touchpad	34
Rear-I/O cover	36
Removing the rear I/O-cover	36
Installing the rear I/O-cover	37
Display assembly	39
Removing the display assembly	39
Installing the display assembly	42
Right I/O-board	44

Removing the right I/O-board.....	44
Installing the right I/O-board.....	45
System board.....	47
Removing the system board.....	47
Installing the system board.....	49
Left I/O-board.....	52
Removing the left I/O-board.....	52
Installing the left I/O-board.....	53
Fan and heat-sink assembly.....	54
Removing the fan and heat-sink assembly.....	54
Installing the fan and heat-sink assembly.....	56
Power-adapter port.....	58
Removing the power-adapter port.....	58
Installing the power-adapter port.....	59
Power-button assembly.....	60
Removing the power-button assembly.....	60
Installing the power-button assembly.....	60
Keyboard.....	61
Removing the keyboard.....	61
Installing the keyboard.....	63
Removing the mechanical keyboard.....	65
Installing the mechanical keyboard.....	67
Palmrest.....	69
Removing the palm rest.....	69
Installing the palm rest.....	70

Chapter 3: Drivers and downloads..... 72

Chapter 4: System setup..... 73

Entering BIOS setup program.....	73
Navigation keys.....	73
System setup options.....	74
Main.....	74
Advanced.....	74
Security.....	76
Secure boot.....	78
Exit.....	79
System and setup password.....	79
Assigning a system setup password.....	79
Deleting or changing an existing system setup password.....	80
Clearing CMOS settings.....	80
Clearing BIOS (System Setup) and System passwords.....	80
Updating the BIOS.....	80
Updating the BIOS in Windows.....	80
Updating the BIOS using the USB drive in Windows.....	81
Updating the BIOS from the F12 One-Time boot menu.....	81
Updating BIOS on systems with BitLocker enabled.....	82

Chapter 5: Troubleshooting..... 83











Handling swollen Lithium-ion batteries..... 83
System-diagnostic lights..... 83
SupportAssist diagnostics..... 84
Recovering the operating system..... 84
Backup media and recovery options..... 85
WiFi power cycle.....85
Drain residual flea power (perform hard reset)..... 85

Chapter 6: Getting help and contacting Alienware..... 87

Working inside your computer

Safety instructions

Use the following safety guidelines to protect your computer from potential damage and to ensure your personal safety. Unless otherwise noted, each procedure included in this document assumes that you have read the safety information that shipped with your computer.

-  **WARNING:** Before working inside your computer, read the safety information that is shipped with your computer. For more safety best practices, see the Regulatory Compliance home page at www.dell.com/regulatory_compliance.
-  **WARNING:** Disconnect your computer from all power sources before opening the computer cover or panels. After you finish working inside the computer, replace all covers, panels, and screws before connecting your computer to an electrical outlet.
-  **CAUTION:** To avoid damaging the computer, ensure that the work surface is flat, dry, and clean.
-  **CAUTION:** To avoid damaging the components and cards, handle them by their edges, and avoid touching the pins and the contacts.
-  **CAUTION:** You should only perform troubleshooting and repairs as authorized or directed by the Dell technical assistance team. Damage due to servicing that is not authorized by Dell is not covered by your warranty. See the safety instructions that is shipped with the product or at www.dell.com/regulatory_compliance.
-  **CAUTION:** Before touching anything inside your computer, ground yourself by touching an unpainted metal surface, such as the metal at the back of the computer. While you work, periodically touch an unpainted metal surface to dissipate static electricity which could harm internal components.
-  **CAUTION:** When you disconnect a cable, pull it by its connector or its pull tab, not the cable itself. Some cables have connectors with locking tabs or thumbscrews that you must disengage before disconnecting the cable. When disconnecting cables, keep them evenly aligned to avoid bending the connector pins. When connecting cables, ensure that the ports and the connectors are correctly oriented and aligned.
-  **CAUTION:** Press and eject any installed card from the media-card reader.
-  **CAUTION:** Exercise caution when handling Lithium-ion batteries in laptops. Swollen batteries should not be used and should be replaced and disposed properly.
-  **NOTE:** The color of your computer and certain components may appear differently than shown in this document.



Working inside your computer

Before working inside your computer

About this task

-  **NOTE:** The images in this document may differ from your computer depending on the configuration you ordered.

Steps

1. Save and close all open files and exit all open applications.
2. Shut down your computer. Click **Start** >  **Power** > **Shut down**.
 -  **NOTE:** If you are using a different operating system, see the documentation of your operating system for shut-down instructions.

3. Disconnect your computer and all attached devices from their electrical outlets.
4. Disconnect all attached network devices and peripherals, such as keyboard, mouse, and monitor from your computer.

 **CAUTION: To disconnect a network cable, first unplug the cable from your computer and then unplug the cable from the network device.**

5. Remove any media card and optical disc from your computer, if applicable.

Electrostatic discharge—ESD protection

ESD is a major concern when you handle electronic components, especially sensitive components such as expansion cards, processors, memory DIMMs, and system boards. Very slight charges can damage circuits in ways that may not be obvious, such as intermittent problems or a shortened product life span. As the industry pushes for lower power requirements and increased density, ESD protection is an increasing concern.

Due to the increased density of semiconductors used in recent Dell products, the sensitivity to static damage is now higher than in previous Dell products. For this reason, some previously approved methods of handling parts are no longer applicable.

Two recognized types of ESD damage are catastrophic and intermittent failures.

- **Catastrophic** – Catastrophic failures represent approximately 20 percent of ESD-related failures. The damage causes an immediate and complete loss of device functionality. An example of catastrophic failure is a memory DIMM that has received a static shock and immediately generates a "No POST/No Video" symptom with a beep code emitted for missing or nonfunctional memory.
- **Intermittent** – Intermittent failures represent approximately 80 percent of ESD-related failures. The high rate of intermittent failures means that most of the time when damage occurs, it is not immediately recognizable. The DIMM receives a static shock, but the tracing is merely weakened and does not immediately produce outward symptoms related to the damage. The weakened trace may take weeks or months to melt, and in the meantime may cause degradation of memory integrity, intermittent memory errors, etc.

The more difficult type of damage to recognize and troubleshoot is the intermittent (also called latent or "walking wounded") failure.

Perform the following steps to prevent ESD damage:

- Use a wired ESD wrist strap that is properly grounded. The use of wireless anti-static straps is no longer allowed; they do not provide adequate protection. Touching the chassis before handling parts does not ensure adequate ESD protection on parts with increased sensitivity to ESD damage.
- Handle all static-sensitive components in a static-safe area. If possible, use anti-static floor pads and workbench pads.
- When unpacking a static-sensitive component from its shipping carton, do not remove the component from the anti-static packing material until you are ready to install the component. Before unwrapping the anti-static packaging, ensure that you discharge static electricity from your body.
- Before transporting a static-sensitive component, place it in an anti-static container or packaging.

ESD field service kit

The unmonitored Field Service kit is the most commonly used service kit. Each Field Service kit includes three main components: anti-static mat, wrist strap, and bonding wire.

Components of an ESD field service kit

The components of an ESD field service kit are:

- **Anti-Static Mat** – The anti-static mat is dissipative and parts can be placed on it during service procedures. When using an anti-static mat, your wrist strap should be snug and the bonding wire should be connected to the mat and to any bare metal on the system being worked on. Once deployed properly, service parts can be removed from the ESD bag and placed directly on the mat. ESD-sensitive items are safe in your hand, on the ESD mat, in the system, or inside a bag.
- **Wrist Strap and Bonding Wire** – The wrist strap and bonding wire can be either directly connected between your wrist and bare metal on the hardware if the ESD mat is not required, or connected to the anti-static mat to protect hardware that is temporarily placed on the mat. The physical connection of the wrist strap and bonding wire between your skin, the ESD mat, and the hardware is known as bonding. Use only Field Service kits with a wrist strap, mat, and bonding wire. Never use wireless wrist straps. Always be aware that the internal wires of a wrist strap are prone to damage from normal wear and tear, and must be checked regularly with a wrist strap tester in order to avoid accidental ESD hardware damage. It is recommended to test the wrist strap and bonding wire at least once per week.
- **ESD Wrist Strap Tester** – The wires inside of an ESD strap are prone to damage over time. When using an unmonitored kit, it is a best practice to regularly test the strap prior to each service call, and at a minimum, test once per week. A wrist strap tester is the

best method for doing this test. If you do not have your own wrist strap tester, check with your regional office to find out if they have one. To perform the test, plug the wrist-strap's bonding-wire into the tester while it is strapped to your wrist and push the button to test. A green LED is lit if the test is successful; a red LED is lit and an alarm sounds if the test fails.

- **Insulator Elements** – It is critical to keep ESD sensitive devices, such as plastic heat sink casings, away from internal parts that are insulators and often highly charged.
- **Working Environment** – Before deploying the ESD Field Service kit, assess the situation at the customer location. For example, deploying the kit for a server environment is different than for a desktop or portable environment. Servers are typically installed in a rack within a data center; desktops or portables are typically placed on office desks or cubicles. Always look for a large open flat work area that is free of clutter and large enough to deploy the ESD kit with additional space to accommodate the type of system that is being repaired. The workspace should also be free of insulators that can cause an ESD event. On the work area, insulators such as Styrofoam and other plastics should always be moved at least 12 inches or 30 centimeters away from sensitive parts before physically handling any hardware components
- **ESD Packaging** – All ESD-sensitive devices must be shipped and received in static-safe packaging. Metal, static-shielded bags are preferred. However, you should always return the damaged part using the same ESD bag and packaging that the new part arrived in. The ESD bag should be folded over and taped shut and all the same foam packing material should be used in the original box that the new part arrived in. ESD-sensitive devices should be removed from packaging only at an ESD-protected work surface, and parts should never be placed on top of the ESD bag because only the inside of the bag is shielded. Always place parts in your hand, on the ESD mat, in the system, or inside an anti-static bag.
- **Transporting Sensitive Components** – When transporting ESD sensitive components such as replacement parts or parts to be returned to Dell, it is critical to place these parts in anti-static bags for safe transport.

ESD protection summary

It is recommended that all field service technicians use the traditional wired ESD grounding wrist strap and protective anti-static mat at all times when servicing Dell products. In addition, it is critical that technicians keep sensitive parts separate from all insulator parts while performing service and that they use anti-static bags for transporting sensitive components.

Transporting sensitive components

When transporting ESD sensitive components such as replacement parts or parts to be returned to Dell, it is critical to place these parts in anti-static bags for safe transport.

After working inside your computer

About this task

 **CAUTION: Leaving stray or loose screws inside your computer may severely damage your computer.**

Steps

1. Replace all screws and ensure that no stray screws remain inside your computer.
2. Connect any external devices, peripherals, or cables you removed before working on your computer.
3. Replace any media cards, discs, or any other parts that you removed before working on your computer.
4. Connect your computer and all attached devices to their electrical outlets.
5. Turn on your computer.

Removing and installing components

NOTE: The images in this document may differ from your computer depending on the configuration you ordered.

Recommended tools

The procedures in this document may require the following tools:

- Phillips screwdriver #0, #1
- Plastic scribe

Screw list

NOTE: When removing screws from a component, it is recommended to note the screw type, the quantity of screws, and then place them in a screw storage box. This is to ensure that the correct number of screws and correct screw type is restored when the component is replaced.

NOTE: Some computers have magnetic surfaces. Ensure that the screws are not left attached to such surfaces when replacing a component.

NOTE: Screw color may vary with the configuration ordered.

Table 1. Screw list



























Component	Secured to	Screw type	Quantity	Screw image
Base cover	Palm-rest assembly	M2.5x9	2	
M.2 2230 solid-state drive in M.2 slot three	Palm-rest assembly	M2x3	2	
M.2 2230 solid-state drive in M.2 slot one or M.2 slot two	M.2 2230 mounting bracket	M2x3	1 per M.2 2230 solid-state drive	
M.2 2230 mounting bracket in M.2 slot one or M.2 slot two	Palm-rest assembly	M2x3	1 per M.2 2230 solid-state drive	
M.2 2280 solid-state drive	Palm-rest assembly	M2x3	1 per M.2 2280 solid-state drive	
Rear I/O-cover	Palm-rest assembly	M2.5x5	2	
Rear I/O-cover	Palm-rest assembly	M2x4.5	2	
Wireless-card bracket	Left I/O-board	M2x3	1	
Display assembly	Palm-rest assembly	M2.5x5	6	
Battery	Palm-rest assembly	M2x4	4	

Table 1. Screw list (continued)

Component	Secured to	Screw type	Quantity	Screw image
Battery	Palm-rest assembly	M2x3	3	
Left I/O-board connector	<ul style="list-style-type: none"> System board Left I/O-board 	M2x4.5	4	
Left I/O-board	Palm-rest assembly	M2x3	3	
Right I/O-board connector	<ul style="list-style-type: none"> System board Right I/O-board 	M2x3	2	
Right I/O-board	Palm-rest assembly	M2x3	3	
Fans	Palm-rest assembly	M2.5x5	2	
System board	Palm-rest assembly	M2x3	5	
Fan and heat-sink assembly	System board	M2x3	10	
Solid-state drive support bracket	Palm-rest assembly	M2x4.5	3	
Touchpad	Palm-rest assembly	M2x2.5	4	
Power-adaptor port bracket	Palm-rest assembly	M2x3	2	
Power-button assembly	Palm-rest assembly	M2x1.9	2	
Keyboard-controller board	Palm-rest assembly	M2x1.9	2	
Keyboard bracket	Keyboard	M1.2x2.1	10	
Keyboard	Palm-rest assembly	M1.2x1.6	28	
Mechanical keyboard bracket	Mechanical keyboard	M1.2x2.5	15	
Mechanical keyboard	Palm-rest assembly	M1.2x2	25	

Major components of Alienware m17 R4

The following image shows the major components of Alienware m17 R4.

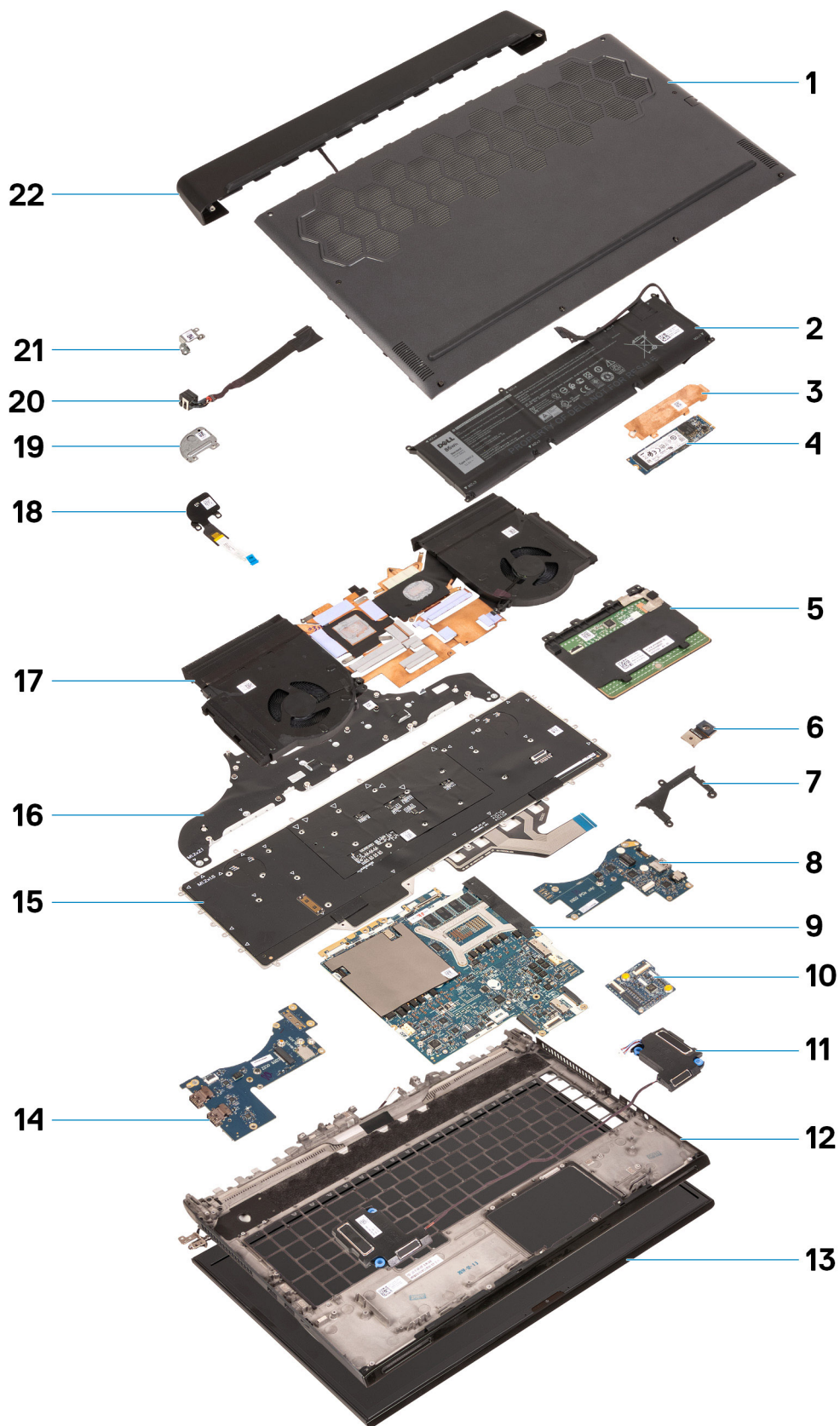

1. Base cover
2. Battery
3. Solid-state drive thermal shield
4. Solid-state drive

5. Touchpad
6. I/O-board cable
7. Solid-state drive support bracket
8. Right I/O-board
9. System board
10. Keyboard-controller board
11. Speakers
12. Palm rest
13. Display assembly
14. Left I/O-board
15. Keyboard
16. Keyboard bracket
17. Fan and heat-sink assembly
18. Power-button assembly
19. Power-button bracket
20. Power-adaptor port
21. Power-adaptor port bracket
22. Rear-I/O cover

Base cover

Removing the base cover

Prerequisites

1. Follow the procedure in [Before working inside your computer.](#)

About this task

 **CAUTION: Ensure that all captive screws are loosened before prying up the base cover.**

The following image indicates the location of the base cover and provides a visual representation of the removal procedure.



2x
M2.5x9



4x
M2.5x9



2x
M2.5x5

1



2

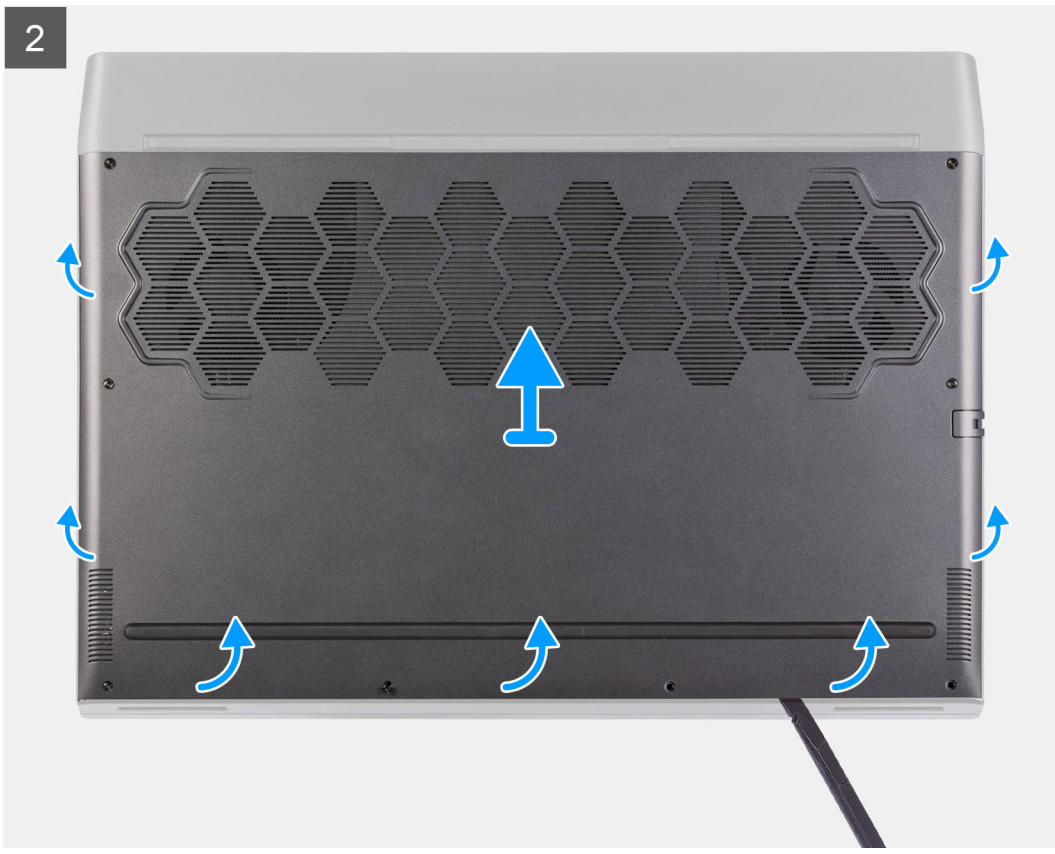

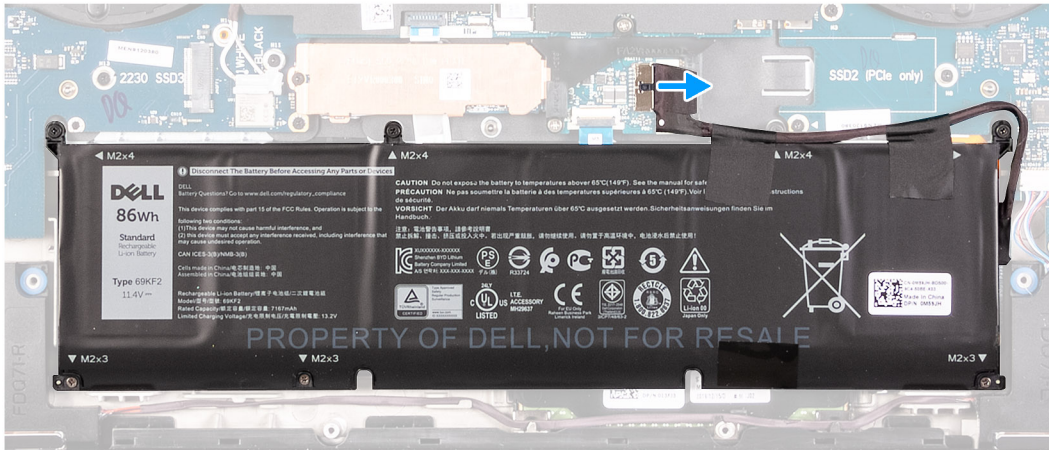
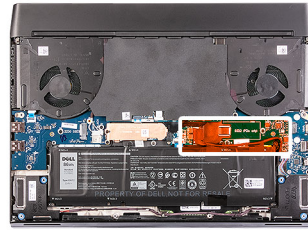

Steps

1. Remove the two screws (M2.5x9) that secure the base cover to the palm-rest assembly.
2. Loosen the six captive screws.
3. Using a plastic scribe, pry the base cover from the gap around the screw holes to release clips on the base cover from the palm-rest assembly.
4. Work on the sides to pry open the base cover.
5. Lift the base cover off the palm-rest assembly.
6. Disconnect the battery from the system board.

NOTE: Disconnect the battery cable only when you are continuing to remove other components from your computer.

7. Press and hold the power button for 5 seconds to ground the computer and drain the flea power.

Installing the base cover

Prerequisites

If you are replacing a component, remove the existing component before performing the installation procedure.

About this task

The following image indicates the location of the base cover and provides a visual representation of the installation procedure.

1

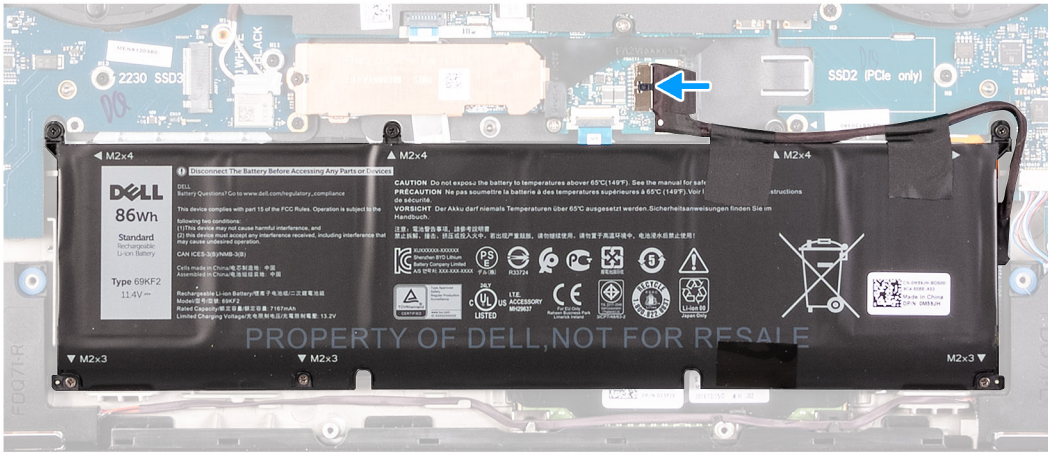
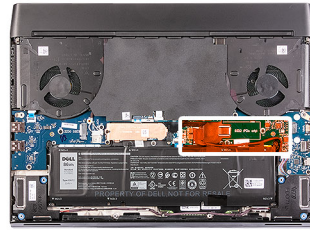

2





2x
M2.5x9



4x
M2.5x9



2x
M2.5x5



Steps

1. Connect the battery cable to the system board, if applicable.
2. Slide the notches on the top of the base cover under the rear I/O-cover and snap the base cover into place on the palm-rest assembly.
3. Tighten the six captive screws on the base cover.
4. Replace the two screws (M2.5x9) that secure the base cover to the palm-rest assembly.

Next steps

1. Follow the procedure in [After working inside your computer](#).

Solid state drive—M.2 slot one

Removing the 2280 solid-state drive from the M.2 slot one

Prerequisites

1. Follow the procedure in [Before working inside your computer](#).
2. Remove the [base cover](#).

About this task

NOTE: This procedure applies only to computers shipped with a 2280 solid-state drive installed in M.2 slot one.

NOTE: Depending on the configuration ordered, your computer may support either 2230 solid-state drive or 2280 solid-state drive in M.2 slot one.

The following image indicates the location of the 2280 solid-state drive in M.2 slot one and provides a visual representation of the removal procedure.

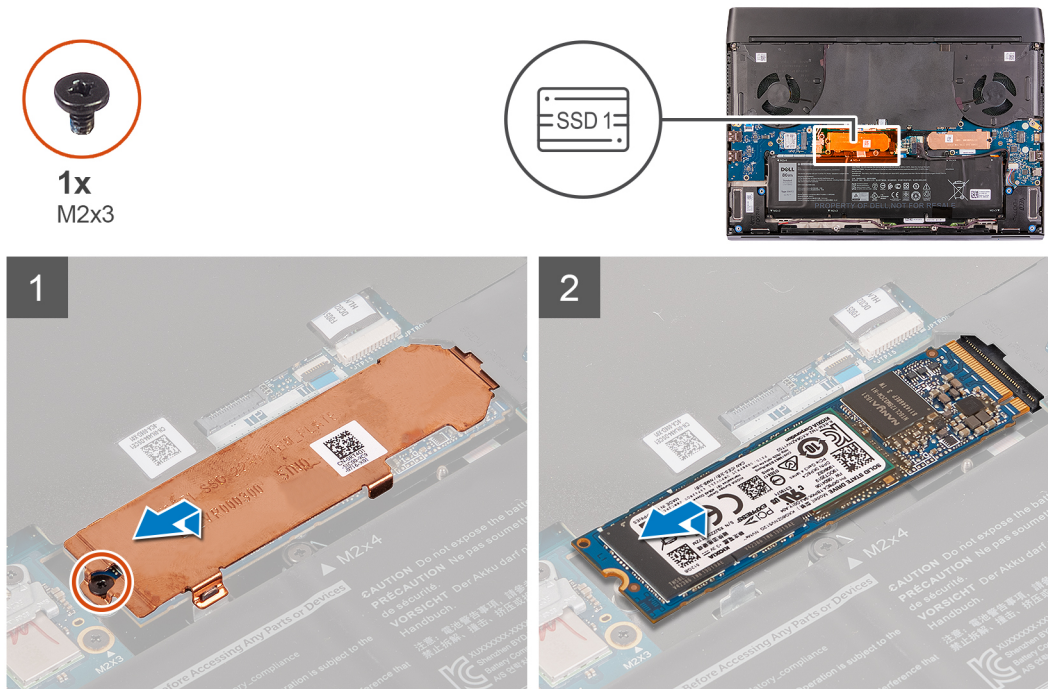

Steps

1. Remove the screw (M2x3) that secures the solid-state drive thermal shield to the palm-rest assembly.
 - NOTE:** A thermal shield is only present if the capacity of the solid-state drive is 512 GB or higher.
2. Lift and remove the solid-state drive thermal shield off the M.2 2280 solid-state drive.
3. Slide and remove the M.2 2280 solid-state drive from the M.2 card slot on the system board.

Installing the 2280 solid-state drive from the M.2 slot one

Prerequisites

If you are replacing a component, remove the existing component before performing the installation procedure.

About this task

- NOTE:** This procedure applies if you are installing a 2280 solid-state drive in M.2 slot one.
- NOTE:** Depending on the configuration ordered, your computer may support either 2230 solid-state drive or 2280 solid-state drive in M.2 slot one.
- NOTE:** A thermal shield is required for optimal heat dissipation if the capacity of the solid-state drive is 512 GB or higher. If a higher configuration solid-state drive is installed after you purchase the computer, contact Dell support to purchase a thermal shield.

The following image indicates the location of the 2280 solid-state drive and provides a visual representation of the installation procedure.



1x
M2x3

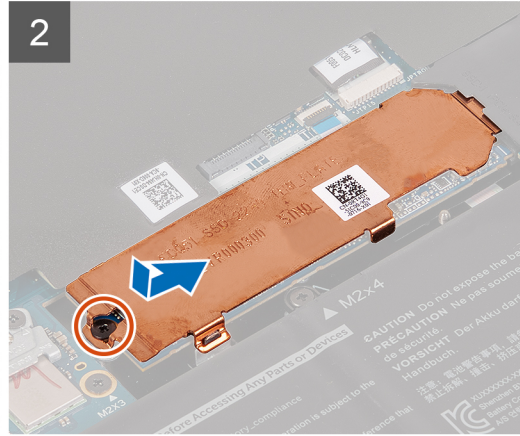
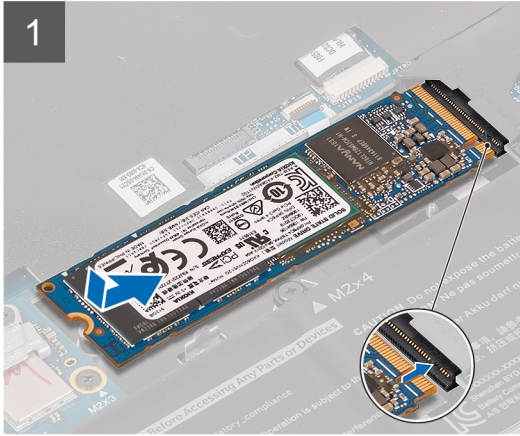
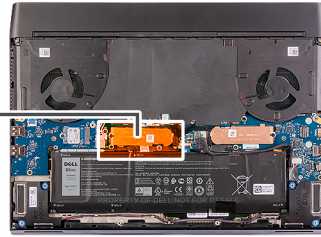

Steps

1. Align the notch on the M.2 2280 solid-state drive with the tab on the M.2 card slot on the system board.
2. Slide the M.2 2280 solid-state drive into the M.2 card slot on the system board.
i **NOTE:** The next step is only applicable if the capacity of the solid-state drive is 512 GB or higher.
3. Slide and align the screw hole of the solid-state drive thermal shield with the screw hole on the palm-rest assembly.
4. Replace the screw (M2x3) that secures the M.2 2280 solid-state drive to the palm-rest assembly.

Next steps

1. Install the [base cover](#).
2. Follow the procedure in [After working inside your computer](#).

Removing the 2230 solid-state drive from the M.2 slot one

Prerequisites

1. Follow the procedure in [Before working inside your computer](#).
2. Remove the [base cover](#).

About this task

- i** **NOTE:** This procedure applies only to computers shipped with a 2230 solid-state drive installed in M.2 slot one.
- i** **NOTE:** Depending on the configuration ordered, your computer may support either 2230 solid-state drive or 2280 solid-state drive in M.2 slot one.

The following image indicates the location of the 2230 solid-state drive that is installed in M.2 slot one and provides a visual representation of the removal procedure.



2x
M2x3

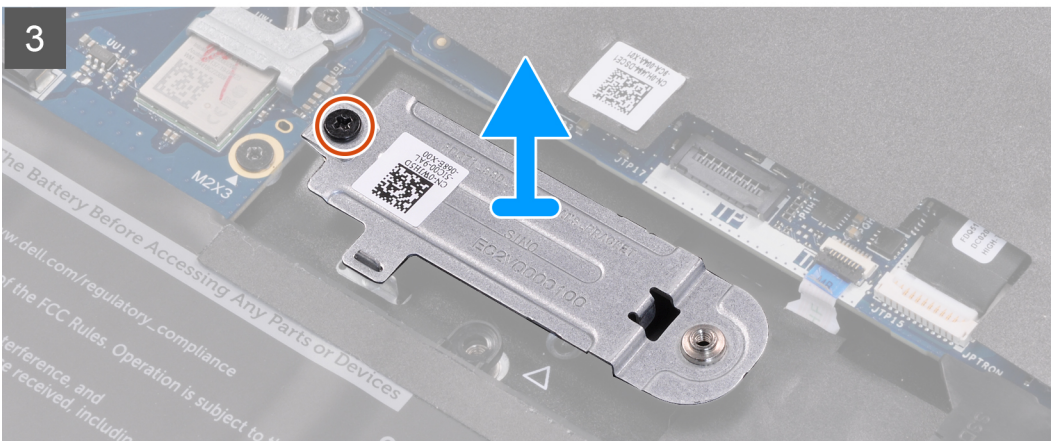
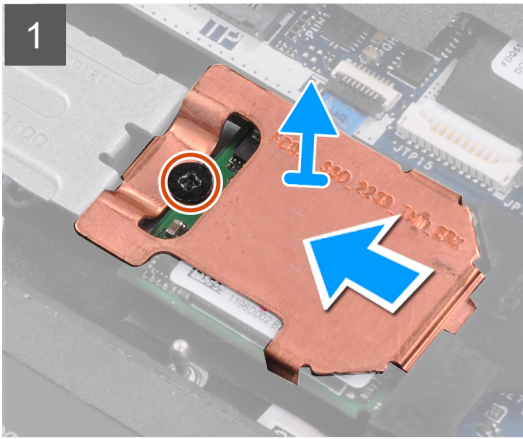
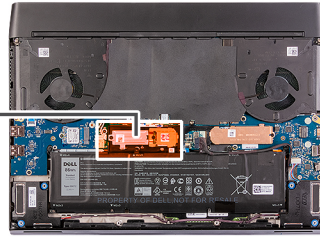

Steps

1. Remove the screw (M2x3) that secures the solid-state drive thermal shield to the M.2 2230 mounting bracket.

(i) NOTE: A thermal shield is only present if the capacity of the solid-state drive is 512 GB or higher.

2. Remove the solid-state drive thermal shield from the M.2 2230 solid-state drive.
3. Lift and remove the M.2 2230 solid-state drive from the M.2 card slot on the system board.
4. Remove the screw (M2x3) that secures the M.2 2230 mounting bracket to the palm-rest assembly.
5. Lift and remove the M.2 2230 mounting bracket from the palm-rest assembly.

Installing the M.2 2230 solid-state drive from the M.2 slot one

Prerequisites

If you are replacing a component, remove the existing component before performing the installation procedure.

About this task

(i) NOTE: This procedure applies if you are installing a 2230 solid-state drive in M.2 slot one.

NOTE: Depending on the configuration ordered, your computer may support either 2230 solid-state drive or 2280 solid-state drive in M.2 slot one.

NOTE: A thermal shield is required for optimal heat dissipation if the capacity of the solid-state drive is 512 GB or higher. If a higher configuration solid-state drive is installed after you purchase the computer, contact Dell support to purchase a thermal shield.

The following image indicates the location of the 2230 solid-state drive that is installed in M.2 slot one and provides a visual representation of the installation procedure.

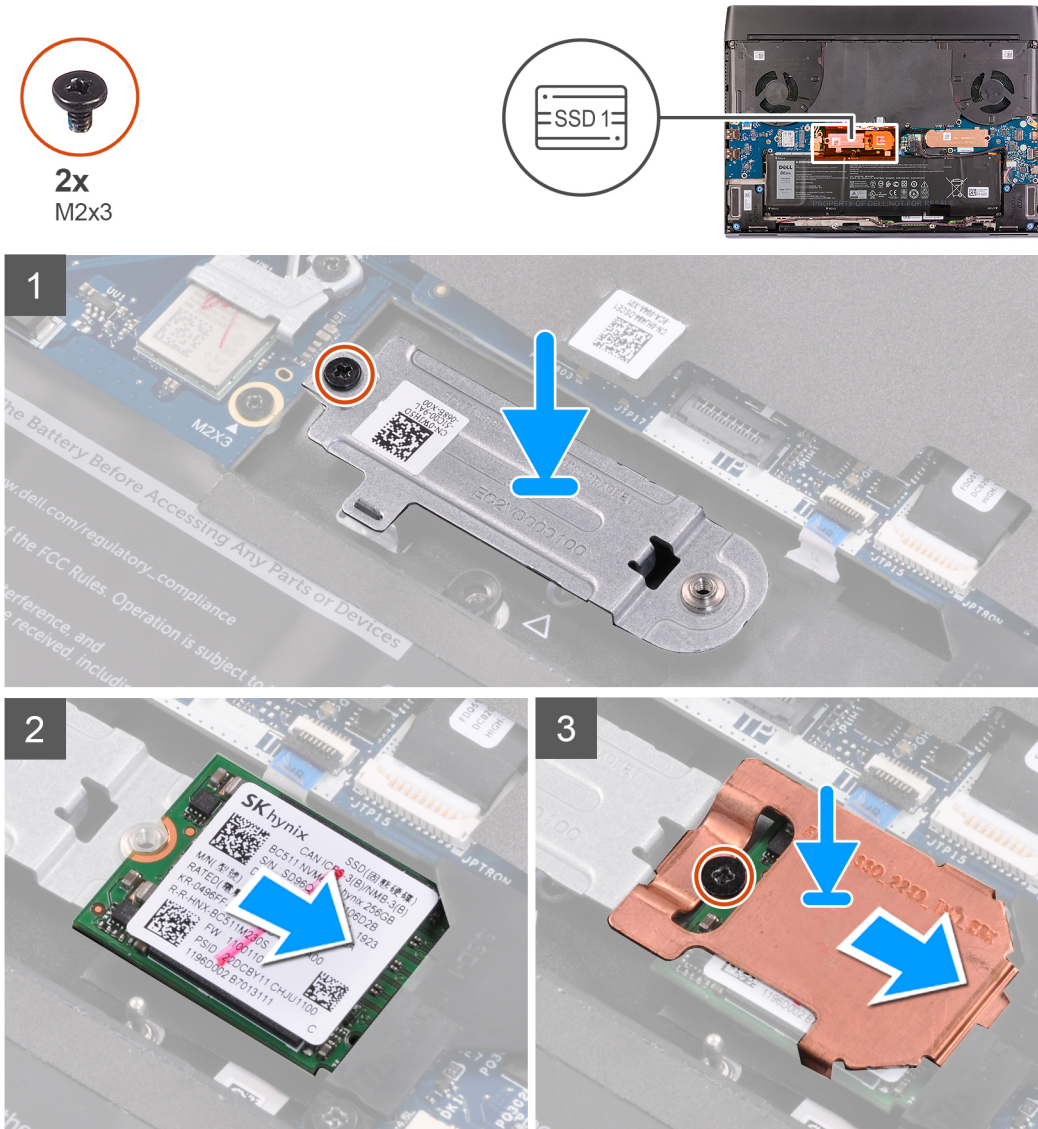

Steps

1. Place and align the M.2 2230 mounting bracket on the palm-rest assembly.
2. Replace the screw (M2x3) that secures the M.2 2230 mounting bracket to the palm-rest assembly.
3. Align the notch on the M.2 2230 solid-state drive with the tab on the M.2 card slot on the system board.
4. Slide the M.2 2230 solid-state drive into the M.2 card slot on the system board.
5. Slide the solid-state drive thermal shield on the M.2 2230 solid-state drive.

NOTE: The next step is only applicable if the capacity of the solid-state drive is 512 GB or higher.

6. Replace the screw (M2x3) that secures the M.2 2230 solid-state drive and the solid-state drive thermal shield to the M.2 2230 mounting bracket.

Next steps

1. Install the [base cover](#).
2. Follow the procedure in [After working inside your computer](#).

Solid state drive—M.2 slot two

Removing the 2280 solid-state drive from the M.2 slot two

Prerequisites

1. Follow the procedure in [Before working inside your computer](#).
2. Remove the [base cover](#).

About this task

- NOTE:** This procedure applies only to computers shipped with a 2280 solid-state drive installed in M.2 slot two.
- NOTE:** Depending on the configuration ordered, your computer may support either 2230 solid-state drive or 2280 solid-state drive in M.2 slot two.

The following image indicates the location of the 2280 solid-state drive that is installed in M.2 slot two and provides a visual representation of the removal procedure.

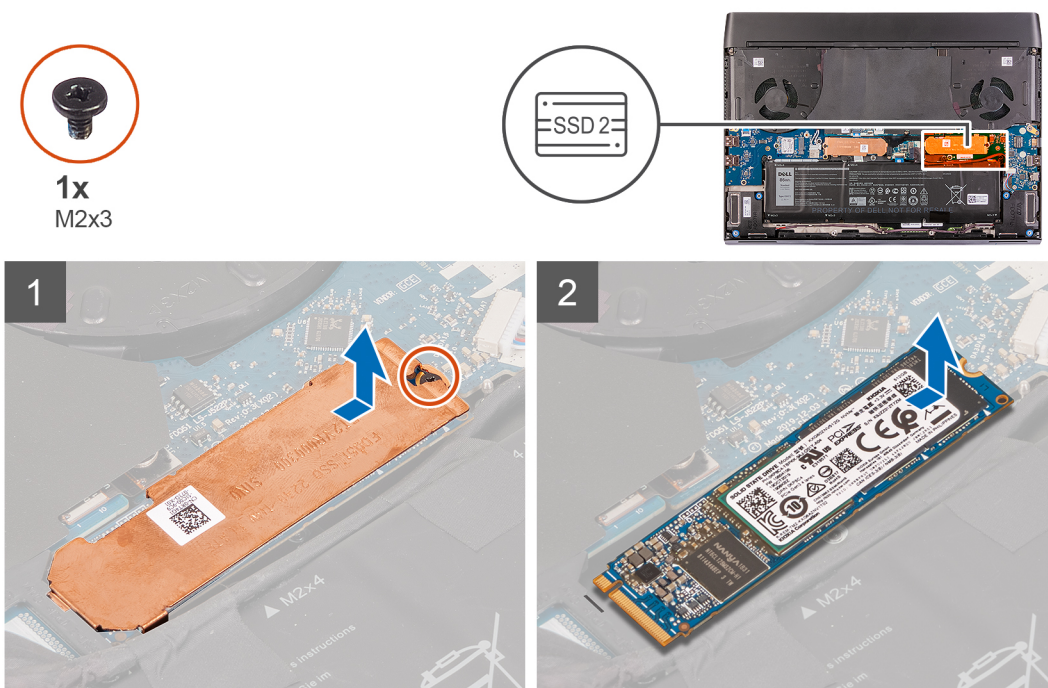

Steps

1. Remove the screw (M2x3) that secures the solid-state drive thermal shield to the palm-rest assembly.

NOTE: A thermal shield is only present if the capacity of the solid-state drive is 512 GB or higher.
2. Lift and remove the solid-state drive thermal shield off the M.2 2280 solid-state drive.
3. Slide and remove the M.2 2280 solid-state drive from the M.2 card slot on the system board.

Installing the 2280 solid-state drive from the M.2 slot two

Prerequisites

If you are replacing a component, remove the existing component before performing the installation procedure.

About this task

- NOTE:** This procedure applies if you are installing a 2280 solid-state drive in M.2 slot two.
- NOTE:** Depending on the configuration ordered, your computer may support either 2230 solid-state drive or 2280 solid-state drive in M.2 slot two.
- NOTE:** A thermal shield is required for optimal heat dissipation if the capacity of the solid-state drive is 512 GB or higher. If a higher configuration solid-state drive is installed after you purchase the computer, contact Dell support to purchase a thermal shield.

The following image indicates the location of the 2280 solid-state drive that is installed in M.2 slot two and provides a visual representation of the installation procedure.

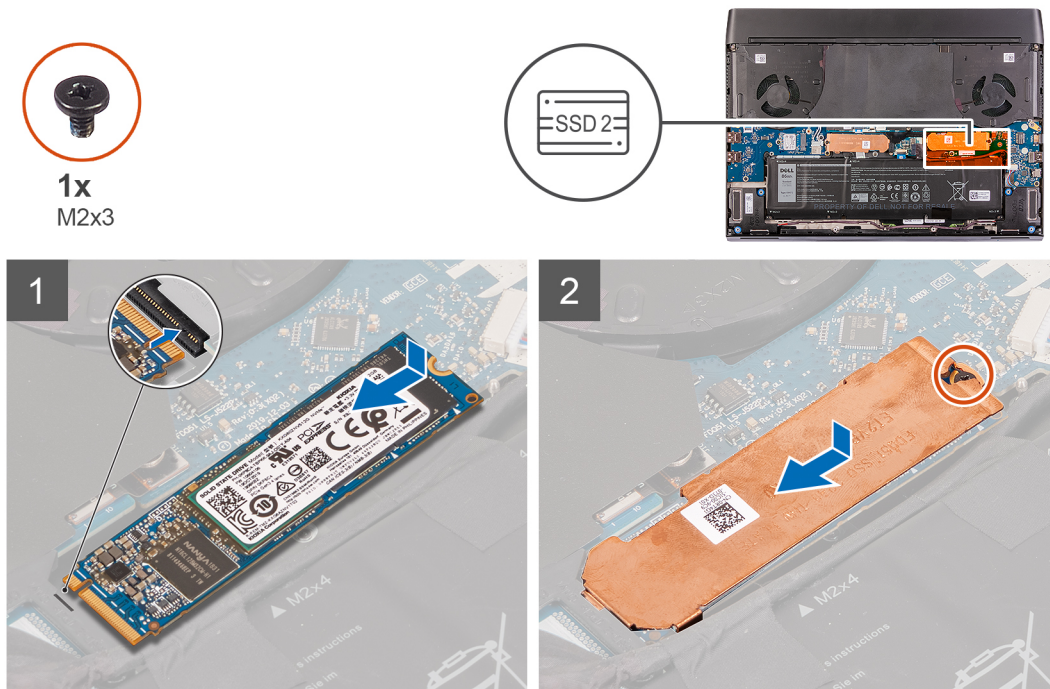

Steps

1. Align the notch on the M.2 2280 solid-state drive with the tab on the M.2 card slot on the system board.
2. Slide the M.2 2280 solid-state drive into the M.2 card slot on the system board.
 - NOTE:** The next step is only applicable if the capacity of the solid-state drive is 512 GB or higher.
3. Slide and align the screw hole of the solid-state drive thermal shield with the screw hole on the palm-rest assembly.
4. Replace the screw (M2x3) that secures the M.2 2280 solid-state drive to the palm-rest assembly.

Next steps

1. Install the [base cover](#).
2. Follow the procedure in [After working inside your computer](#).

Removing the 2230 solid-state drive from the M.2 slot two

Prerequisites

1. Follow the procedure in [Before working inside your computer.](#)
2. Remove the [base cover.](#)

About this task

- NOTE:** This procedure applies only to computers shipped with a 2230 solid-state drive installed in M.2 slot two.
- NOTE:** Depending on the configuration ordered, your computer may support either 2230 solid-state drive or 2280 solid-state drive in M.2 slot two.

The following image indicates the location of the 2230 solid-state drive that is installed in M.2 slot two and provides a visual representation of the removal procedure.

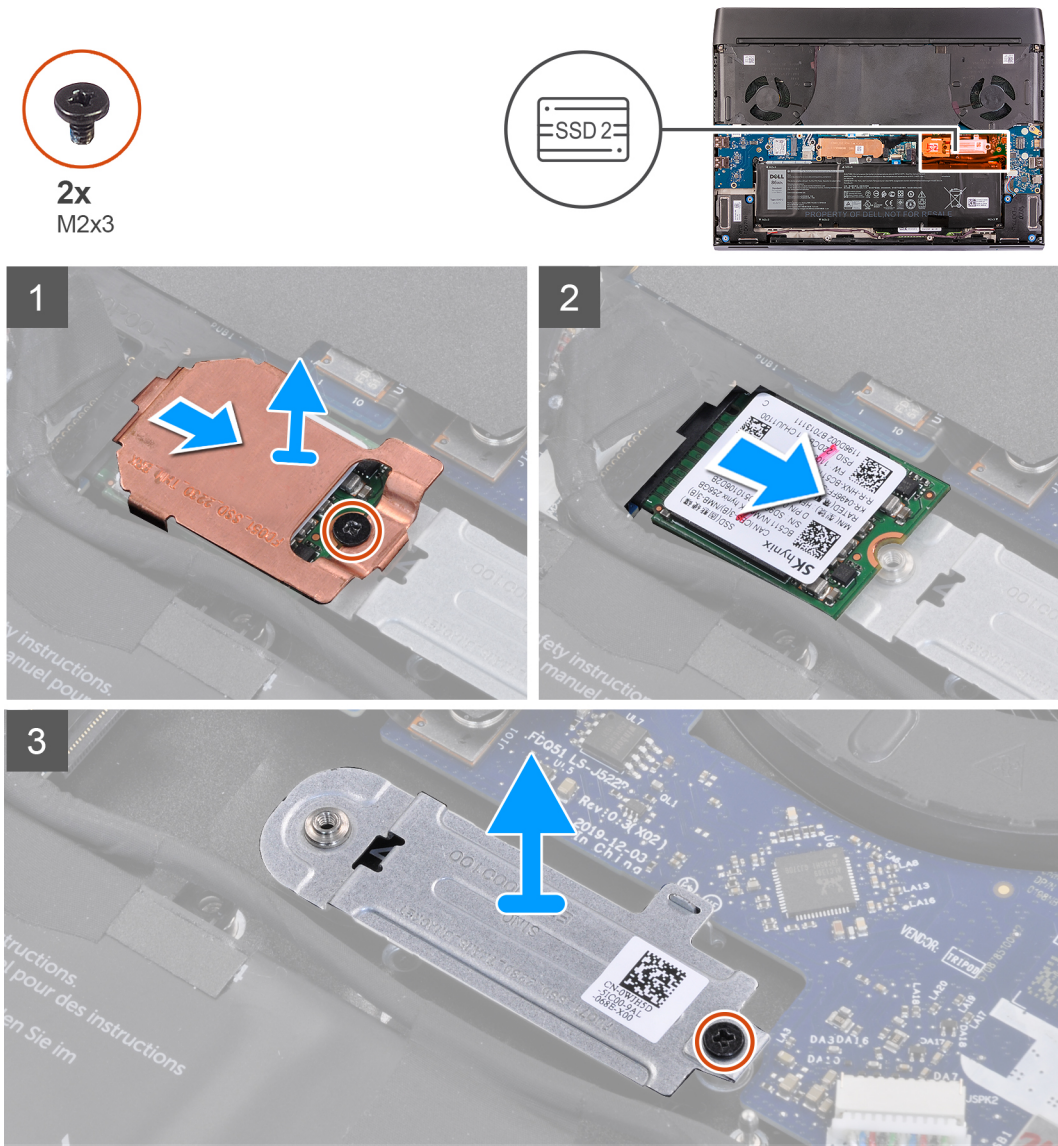

Steps

1. Remove the screw (M2x3) that secures the solid-state drive thermal shield to the M.2 2230 mounting bracket.
 - NOTE:** A thermal shield is only present if the capacity of the solid-state drive is 512 GB or higher.

2. Remove the solid-state drive thermal shield from the M.2 2230 solid-state drive.
3. Lift and remove the M.2 2230 solid-state drive from the M.2 card slot on the system board.
4. Remove the screw (M2x3) that secures the M.2 2230 mounting bracket to the palm-rest assembly.
5. Lift and remove the M.2 2230 mounting bracket from the palm-rest assembly.

Installing the 2230 solid-state drive from the M.2 slot two

Prerequisites

If you are replacing a component, remove the existing component before performing the installation procedure.

About this task

- NOTE:** This procedure applies if you are installing a 2230 solid-state drive in M.2 slot two.
- NOTE:** Depending on the configuration ordered, your computer may support either 2230 solid-state drive or 2280 solid-state drive in M.2 slot two.
- NOTE:** A thermal shield is required for optimal heat dissipation if the capacity of the solid-state drive is 512 GB or higher. If a higher configuration solid-state drive is installed after you purchase the computer, contact Dell support to purchase a thermal shield.

The following image indicates the location of the 2230 solid-state drive that is installed in M.2 slot two and provides a visual representation of the installation procedure.



2x
M2x3

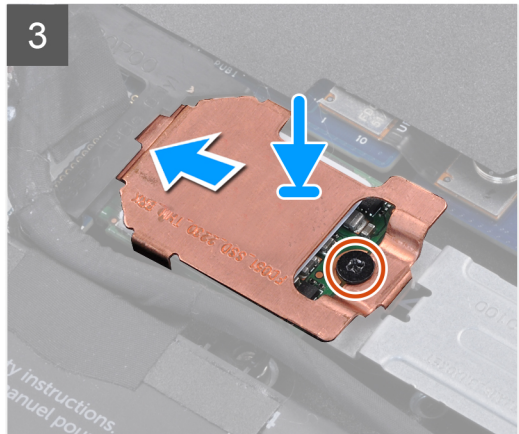
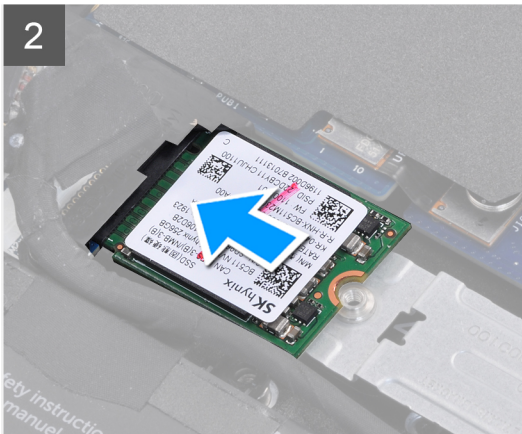
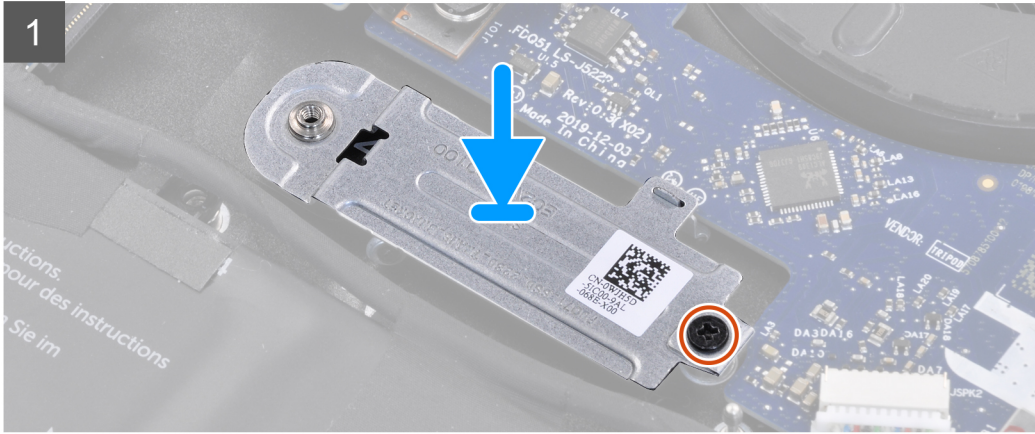
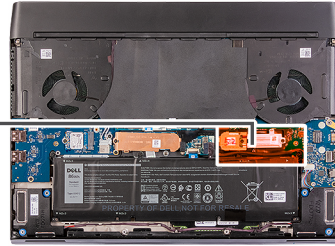

Steps

1. Place and align the M.2 2230 mounting bracket on the palm-rest assembly.
2. Replace the screw (M2x3) that secures the M.2 2230 mounting bracket to the palm-rest assembly.
3. Align the notch on the M.2 2230 solid-state drive with the tab on the M.2 card slot on the system board.
4. Slide the M.2 2230 solid-state drive into the M.2 card slot on the system board.
5. Slide the solid-state drive thermal shield on the M.2 2230 solid-state drive.

(i) NOTE: The next step is only applicable if the capacity of the solid-state drive is 512 GB or higher.

6. Replace the two screws (M2x3) that secure the M.2 2230 solid-state drive and the solid-state drive thermal shield to the M.2 2230 mounting bracket.

Next steps

1. Install the [base cover](#).
2. Follow the procedure in [After working inside your computer](#).

Solid state drive—M.2 slot three

Removing the 2230 solid-state drive from the M.2 slot three

Prerequisites

1. Follow the procedure in [Before working inside your computer.](#)
2. Remove the [base cover.](#)

About this task

NOTE: M.2 slot three only supports 2230 solid-state drive.

The following image indicates the location of the 2230 solid-state drive that is installed in M.2 slot three and provides a visual representation of the removal procedure.

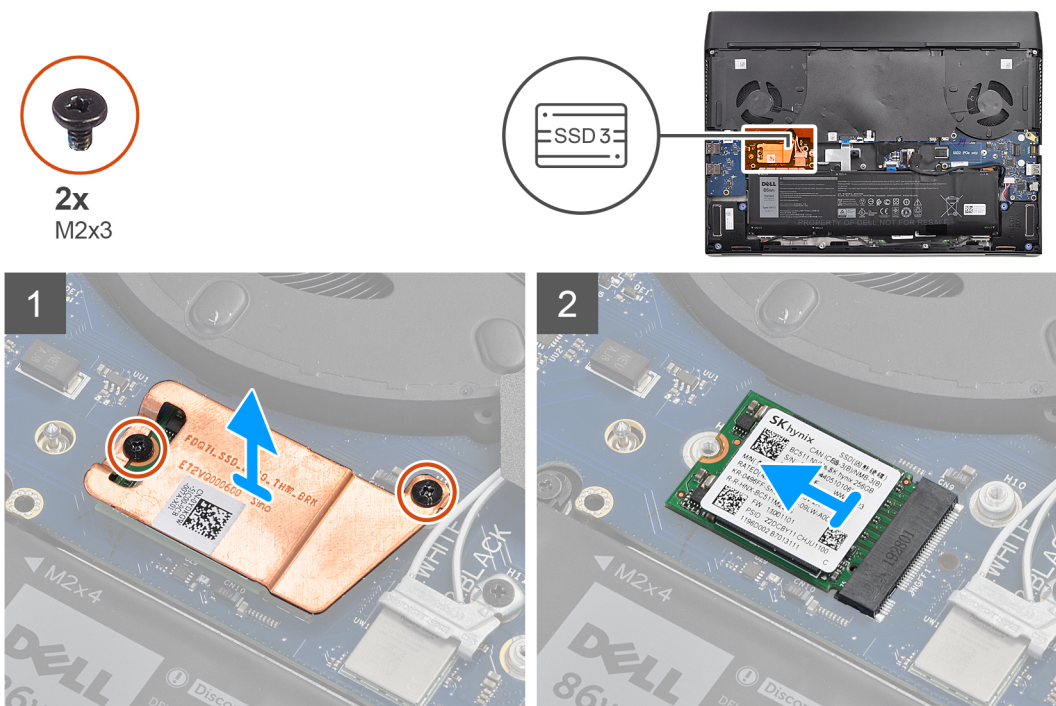

Steps

1. Remove the two screws (M2x3) that secure the solid-state drive thermal shield to the left I/O-board.
NOTE: A thermal shield is only present if the capacity of the solid-state drive is 512 GB or higher.
2. Remove the solid-state drive thermal shield from the M.2 2230 solid-state drive.
3. Remove the M.2 2230 solid-state drive from the M.2 card slot on the left I/O-board.

Installing the 2230 solid-state drive from the M.2 slot three

Prerequisites

If you are replacing a component, remove the existing component before performing the installation procedure.

About this task

NOTE: M.2 slot three only supports 2230 solid-state drive.

NOTE: A thermal shield is required for optimal heat dissipation if the capacity of the solid-state drive is 512 GB or higher. If a higher configuration solid-state drive is installed after you purchase the computer, contact Dell support to purchase a thermal shield.

The following image indicates the location of the 2230 solid-state drive that is installed in M.2 slot three and provides a visual representation of the installation procedure.

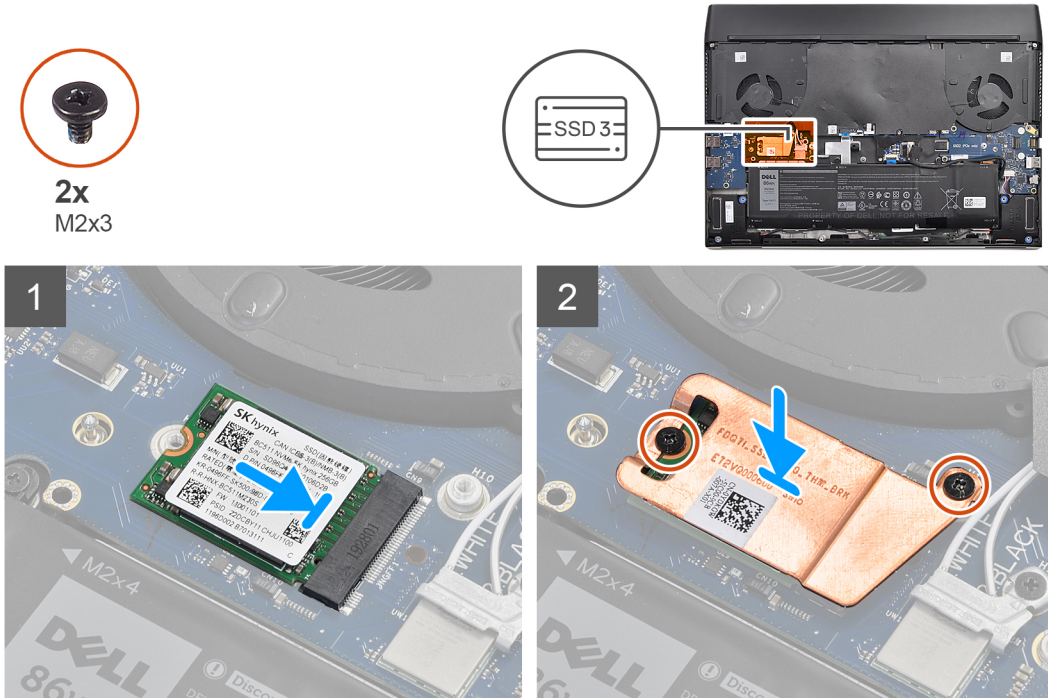

Steps

1. Align the notch on the M.2 2230 solid-state drive with the tab on the M.2 card slot on the left I/O-board.
2. Slide the M.2 2230 solid-state drive into the M.2 card slot on the left I/O-board.

NOTE: The next step is only applicable if the capacity of the solid-state drive is 512 GB or higher.

3. Place the solid-state drive thermal shield on the M.2 2230 solid-state drive.
4. Replace the two screws (M2x3) that secure the M.2 2230 solid-state drive and the solid-state drive thermal shield to the left I/O-board.

Next steps

1. Install the [base cover](#).
2. Follow the procedure in [After working inside your computer](#).

Battery

Lithium-ion battery precautions

CAUTION:

- Exercise caution when handling Lithium-ion batteries.
- Discharge the battery completely before removing it. Disconnect the AC power adapter from the system and operate the computer solely on battery power—the battery is fully discharged when the computer no longer turns on when the power button is pressed.
- Do not crush, drop, mutilate, or penetrate the battery with foreign objects.

- Do not expose the battery to high temperatures, or disassemble battery packs and cells.
- Do not apply pressure to the surface of the battery.
- Do not bend the battery.
- Do not use tools of any kind to pry on or against the battery.
- Ensure any screws during the servicing of this product are not lost or misplaced, to prevent accidental puncture or damage to the battery and other system components.
- If the battery gets stuck inside your computer as a result of swelling, do not try to release it as puncturing, bending, or crushing a lithium-ion battery can be dangerous. In such an instance, contact Dell technical support for assistance. See www.dell.com/contactdell.
- Always purchase genuine batteries from www.dell.com or authorized Dell partners and resellers.
- Swollen batteries should not be used and should be replaced and disposed properly. For guidelines on how to handle and replace swollen Lithium-ion batteries, see [Handling swollen Lithium-ion batteries](#).

Removing the battery

Prerequisites

1. Follow the procedure in [Before working inside your computer](#).
2. Remove the [base cover](#).

About this task

△ **CAUTION:** This computer is designed without an RTC coin cell-battery. After the battery is disconnected or when the battery is fully discharged, an RTC reset cycle will occur when you restart the computer. The computer turns on and off three times. An "Invalid Configuration" error message is displayed prompting you to enter the BIOS and configure the date and time. The computer starts functioning normally after setting the date and time.

△ **CAUTION:** Disconnecting the battery cable resets the BIOS setup program's settings to default. It is recommended that you note the BIOS setup program's settings before removing/disconnecting the battery.

The following image indicates the location of the battery and provides a visual representation of the removal procedure.

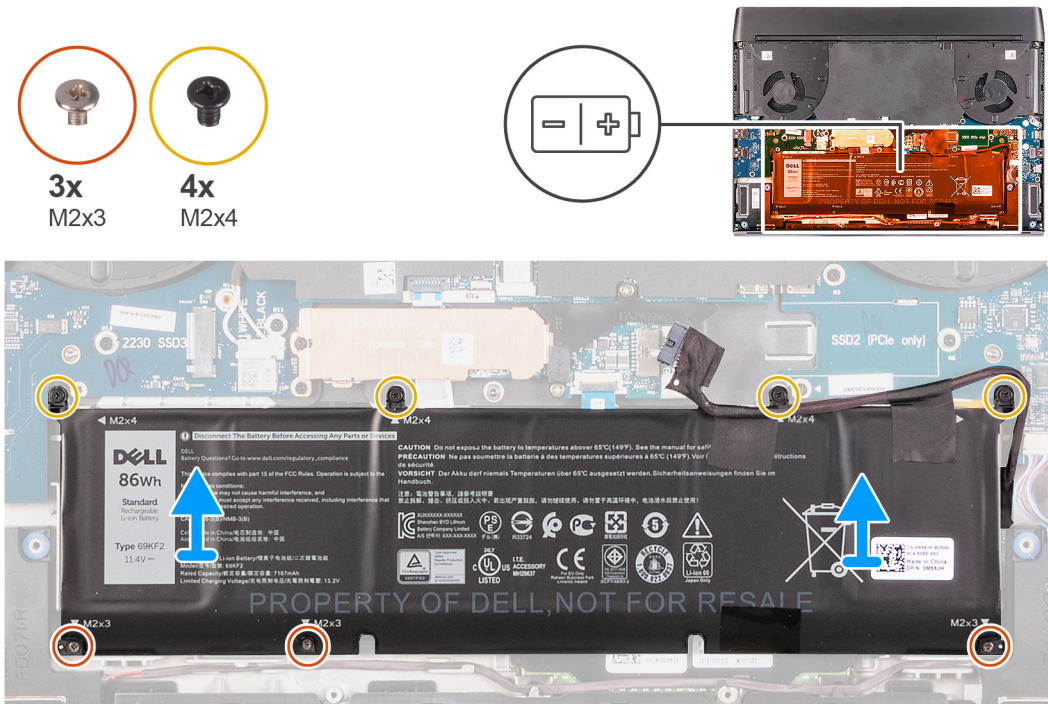

Steps

1. Disconnect the battery cable from the system board, if applicable.
2. Remove the four screws (M2x4) that secure the battery to the palm-rest assembly.
3. Remove the three screws (M2x3) that secure the battery to the palm-rest assembly.
4. Lift the battery up, and then remove it from the palm-rest assembly.

Installing the battery

Prerequisites

If you are replacing a component, remove the existing component before performing the installation procedure.

About this task

The following image indicates the location of the battery and provides a visual representation of the installation procedure.

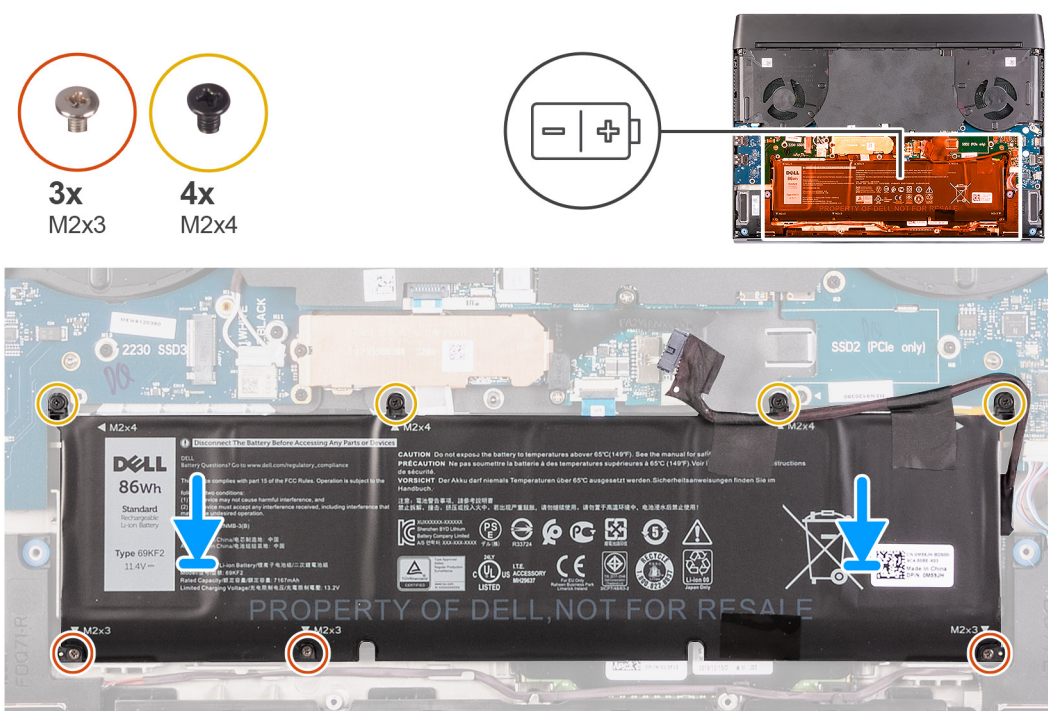

Steps

1. Place the battery on the palm-rest assembly.
2. Replace the three screws (M2x3) that secure the battery to the palm-rest assembly.
3. Replace the four screws (M2x4) that secure the battery to the palm-rest assembly.
4. Connect the battery cable to the system board.

Next steps

1. Install the [base cover](#).
2. Follow the procedure in [After working inside your computer](#).

Speakers

Removing the speakers

Prerequisites

1. Follow the procedure in [Before working inside your computer.](#)
2. Remove the [base cover.](#)

About this task

The following image indicates the location of the speakers and provides a visual representation of the removal procedure.

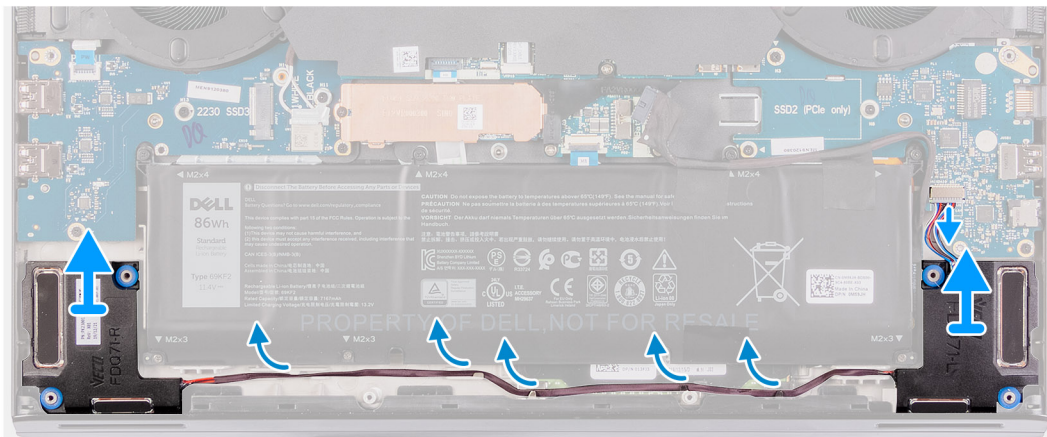
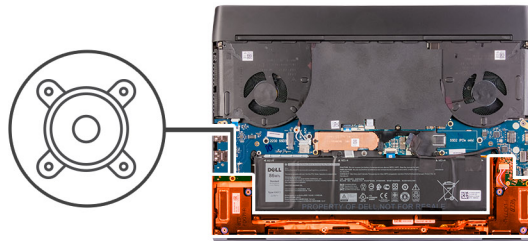

Steps

1. Disconnect the speaker cable from the right I/O-board.
2. Lift the right speaker off the palm-rest assembly.
3. Remove the speaker cables from the routing guides on the palm-rest assembly.
4. Lift the left speaker off the palm-rest assembly.

Installing the speakers

Prerequisites

If you are replacing a component, remove the existing component before performing the installation procedure.

About this task

The following image indicates the location of the speakers and provides a visual representation of the installation procedure.

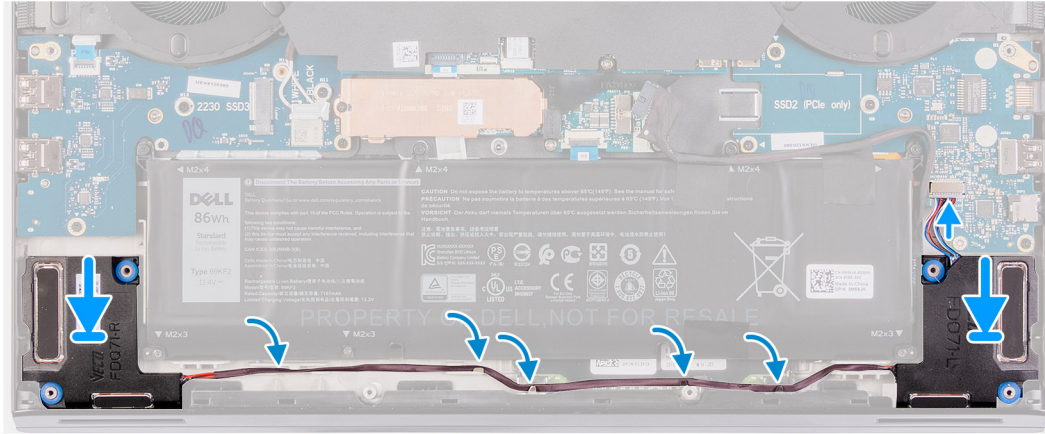
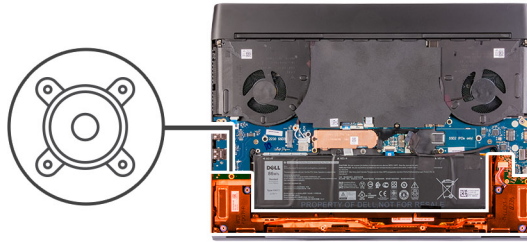

Steps

1. Using the alignment posts, place the left speaker on the palm-rest assembly.
 - i** **NOTE:** Ensure that the alignment posts on the palm-rest and keyboard assembly are threaded through the rubber grommets on the speaker.
 - i** **NOTE:** If the rubber grommets are pushed out of the speakers when removing the speakers, push them back in place before replacing the speakers.
2. Route the speaker cable through the routing guides on the palm-rest assembly.
3. Using the alignment posts, place the right speaker on the palm-rest assembly.
 - i** **NOTE:** Ensure that the alignment posts on the palm-rest and keyboard assembly are threaded through the rubber grommets on the speaker.
 - i** **NOTE:** If the rubber grommets are pushed out of the speakers when removing the speakers, push them back in place before replacing the speakers.
4. Connect the speaker cable to the right I/O-board.

Next steps

1. Install the [base cover](#).
2. Follow the procedure in [After working inside your computer](#).

Keyboard-controller board

Removing the keyboard-controller board

Prerequisites

1. Follow the procedure in [Before working inside your computer](#).
2. Remove the [base cover](#).
3. Remove the [battery](#).

About this task

The following image indicates the location of the keyboard-controller board and provides a visual representation of the removal procedure.



2x
M2x1.9

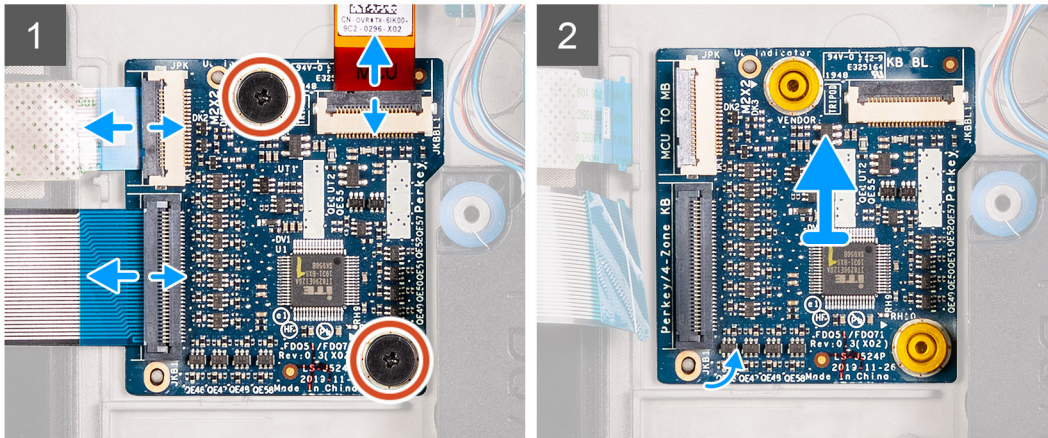
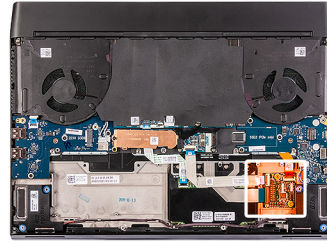

Steps

1. Open the latch, and disconnect the keyboard-backlight cable from the keyboard-controller board.
2. Open the latch, and disconnect the keyboard-controller board cable from the keyboard-controller board.
3. Open the latch, and disconnect the keyboard cable from the keyboard-controller board.
4. Remove the two screws (M2x1.9) that secure the keyboard-controller board to the palm-rest assembly.
5. Lift the keyboard-controller board from the palm-rest assembly.

Installing the keyboard-controller board

Prerequisites

If you are replacing a component, remove the existing component before performing the installation procedure.

About this task

The following image indicates the location of the keyboard-controller board and provides a visual representation of the installation procedure.



2x
M2x1.9

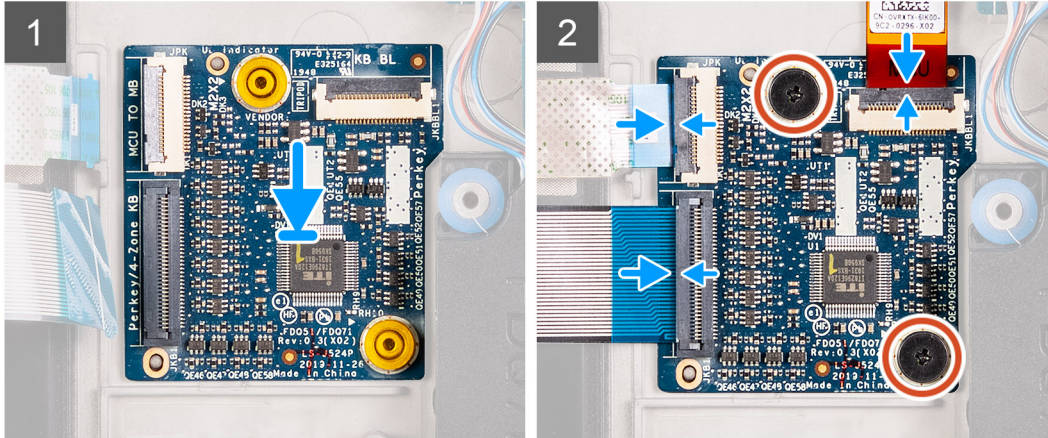
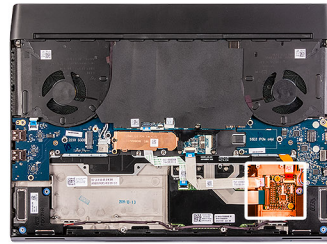

Steps

1. Using the alignment pins, place the keyboard-controller board into place on the palm-rest assembly.
2. Align the screw holes on the keyboard-controller board with the screw holes on the palm-rest assembly.
3. Connect the keyboard-controller board cable to the keyboard-controller board and close the latch.
4. Connect the keyboard cable to the keyboard-controller board and close the latch.
5. Connect the keyboard-backlight cable to the keyboard-controller board and close the latch.
6. Replace the two screws (M2x1.9) that secure the keyboard-controller board to the palm-rest assembly.

Next steps

1. Install the [battery](#).
2. Install the [base cover](#).
3. Follow the procedure in [After working inside your computer](#).

Touchpad

Removing the touchpad

Prerequisites

1. Follow the procedure in [Before working inside your computer](#).
2. Remove the [base cover](#).
3. Remove the [battery](#).

About this task

The following image indicates the location of the touchpad and provides a visual representation of the removal procedure.



4x
M2x2.5

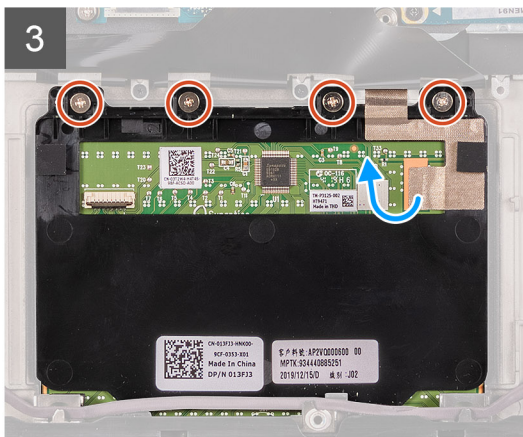
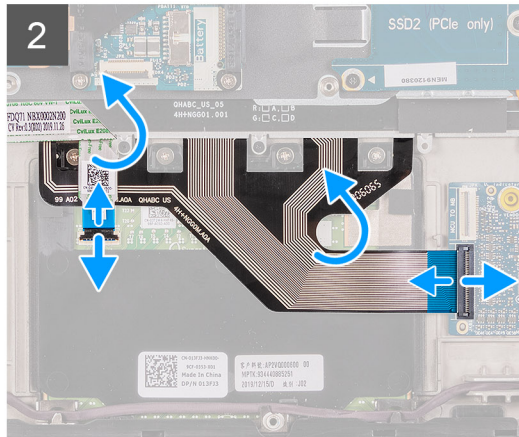
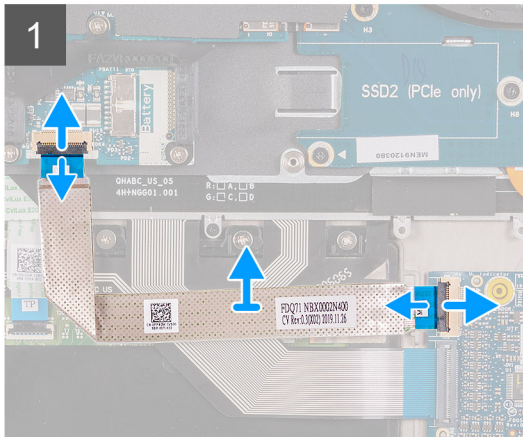
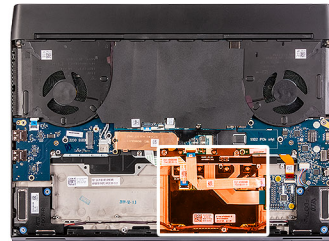

Steps

1. Open the latch, and disconnect the keyboard-controller board-cable from keyboard-controller board.
2. Open the latch, and disconnect the keyboard-controller board-cable from system board.
3. Lift the keyboard-controller board-cable off the palm-rest assembly.
4. Open the latch, and disconnect the keyboard cable from the keyboard-controller board.
5. Fold up the keyboard cable.
6. Open the latch, and disconnect the touchpad cable from the touchpad.
7. Lift the touchpad cable from the palm-rest assembly.
8. Remove the four (M2x2.5) screws that secure the touchpad to the palm-rest assembly.
9. Peel off the tape that secures the touchpad to the palm-rest assembly.
10. Lift the touchpad off the palm-rest assembly.

Installing the touchpad

Prerequisites

If you are replacing a component, remove the existing component before performing the installation procedure.

About this task

The following image indicates the location of the touchpad and provides a visual representation of the installation procedure.

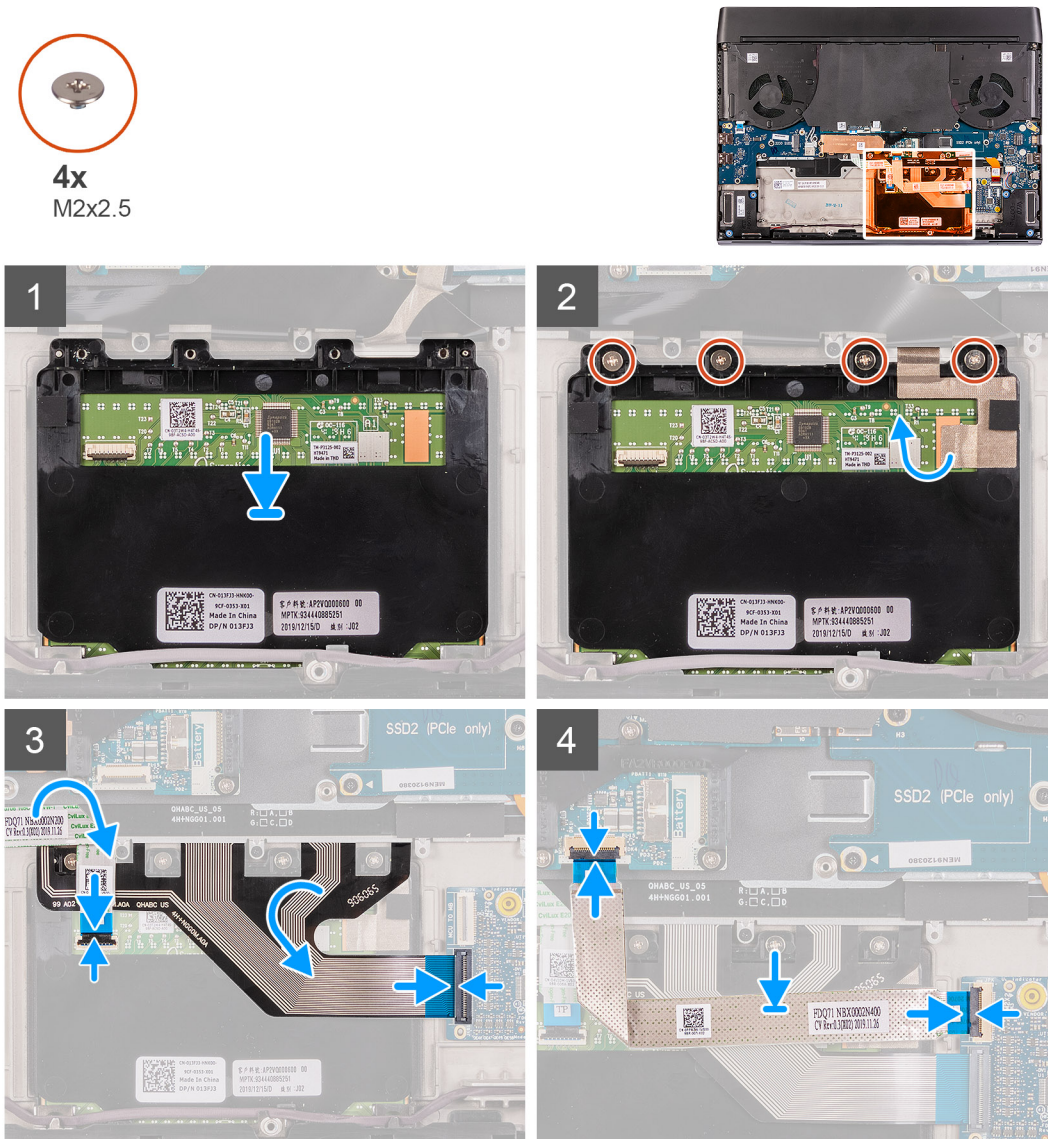

Steps

1. Place the touchpad into the slot on the palm-rest assembly.
i **NOTE:** Turn the computer over, and open the display. Ensure that the touchpad is equally aligned along all four sides.
2. Replace the four (M2x2.5) screws that secure the touchpad to the palm-rest assembly.
3. Adhere the tape that secures the touchpad to the palm-rest assembly.
4. Connect the touchpad cable to the touchpad, and close the latch.
i **NOTE:** This step is only applicable when the touchpad cable is not being replaced.
5. Fold down the keyboard cable.
6. Connect the keyboard cable to the keyboard-controller board and close the latch.
7. Connect the keyboard-controller board cable to the keyboard-controller board and close the latch.
8. Connect the keyboard-controller board cable to the system board and close the latch.

Next steps

1. Install the [battery](#).
2. Install the [base cover](#).
3. Follow the procedure in [After working inside your computer](#).

Rear-I/O cover

Removing the rear I/O-cover

Prerequisites

1. Follow the procedure in [Before working inside your computer](#).
2. Remove the [base cover](#).

About this task

The following image indicates the location of the rear I/O-cover and provides a visual representation of the removal procedure.



2x
M2.5x5



2x
M2x4.5

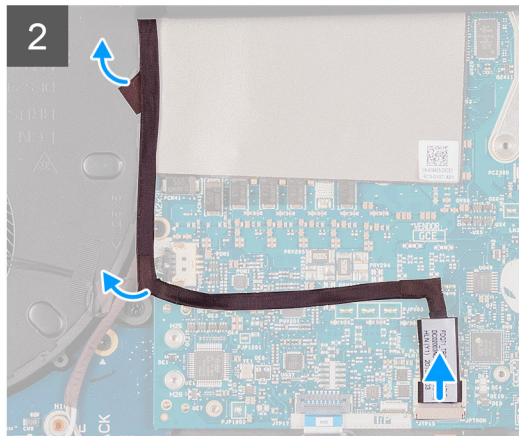
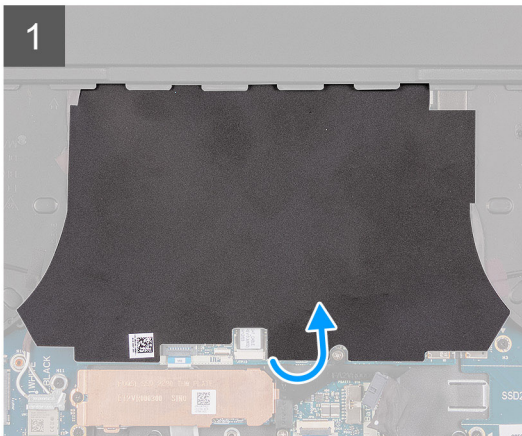
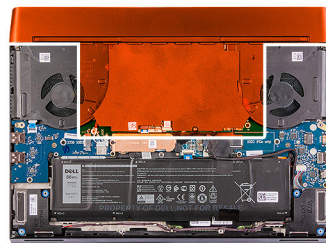

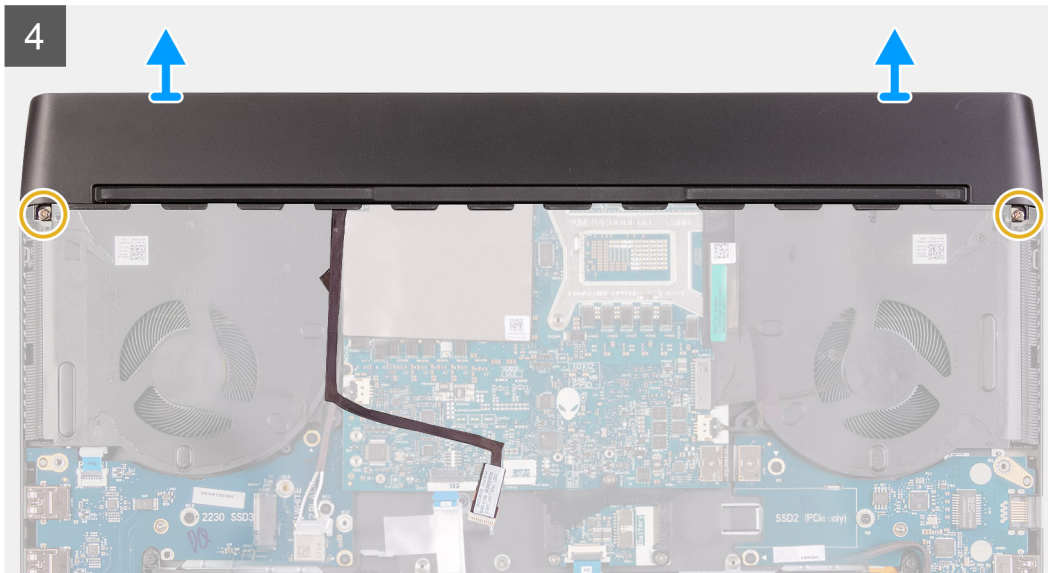

Steps

1. Peel and remove the Mylar that covers the system board.
2. Disconnect and peel the Tron-light cable from the system board.

CAUTION: To prevent damaging your computer, ensure that the Tron-light cable has been disconnected from the system board before removing the rear I/O-cover.

3. Remove the two screws (M2.5x5) that secure the rear I/O-cover to the palm-rest assembly.
4. Remove the two screws (M2x4.5) that secure the rear I/O-cover to the palm-rest assembly.
5. Firmly grasp the sides of your computer with both hands and push the rubber feet on the rear I/O-cover outwards with your thumbs to release the rear I/O-cover from the palm-rest assembly.
6. Lift the rear I/O-cover from the palm-rest assembly.

Installing the rear I/O-cover

Prerequisites

If you are replacing a component, remove the existing component before performing the installation procedure.

About this task

The following image indicates the location of the rear I/O-cover and provides a visual representation of the installation procedure.



2x
M2.5x5



2x
M2x4.5

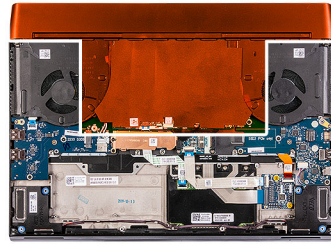

1

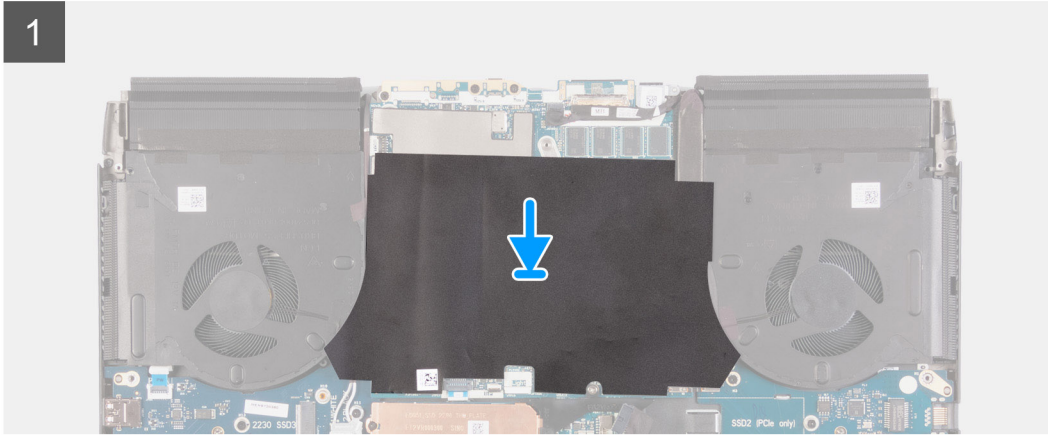

2



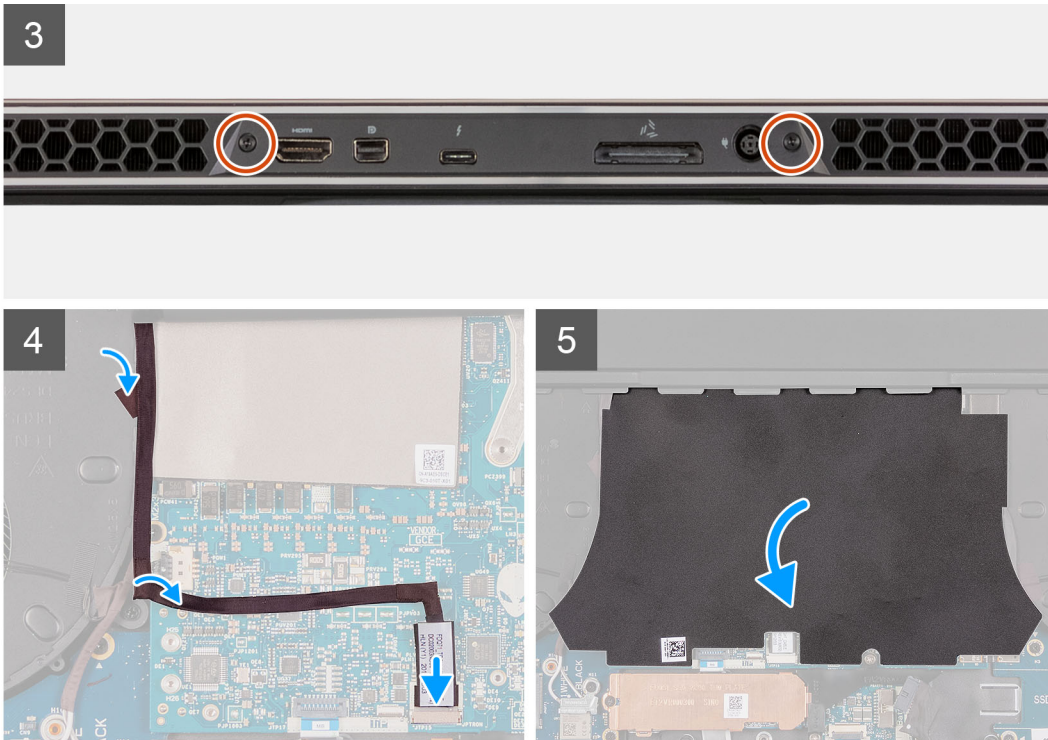

Steps

1. Adhere the Mylar into place onto the system board.
2. Push the rear I/O-cover into the palm-rest assembly snapping it into place.
 - ⓘ **NOTE:** To avoid damaging your computer, ensure that the Tron light cable is not pinched and that the Mylar is pasted on the system board before snapping the rear I/O-cover into place.
3. Replace the two screws (M2x4.5) that secure the rear I/O-cover to the palm-rest assembly.
4. Replace the two screws (M2.5x5) that secure the rear I/O-cover to the palm-rest assembly.
5. Connect the Tron light cable to the system board.
6. Route and adhere the Tron light cable into place on the system board underneath the mylar.

Next steps

1. Install the [base cover](#).
2. Follow the procedure in [After working inside your computer](#).

Display assembly

Removing the display assembly

Prerequisites

1. Follow the procedure in [Before working inside your computer](#).
2. Remove the [base cover](#).
3. Remove the [rear I/O-cover](#).

About this task

ⓘ **NOTE:** The display assembly is a Hinge-Up Display (HUD) and cannot be further disassembled.

The following image indicates the location of the display assembly and provides a visual representation of the removal procedure.



1x
M2x3

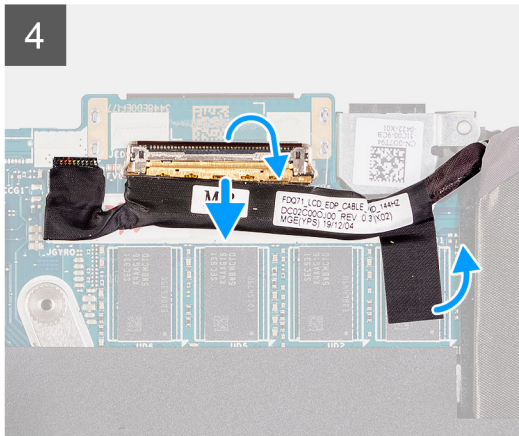
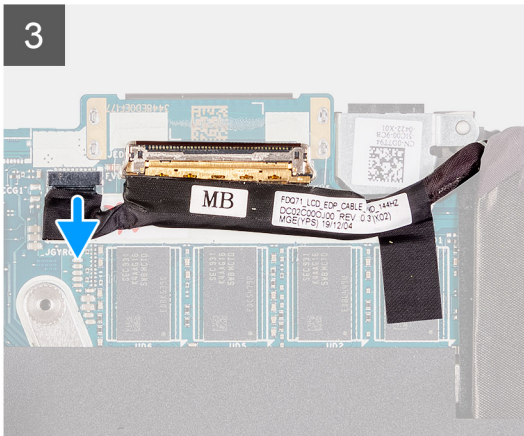
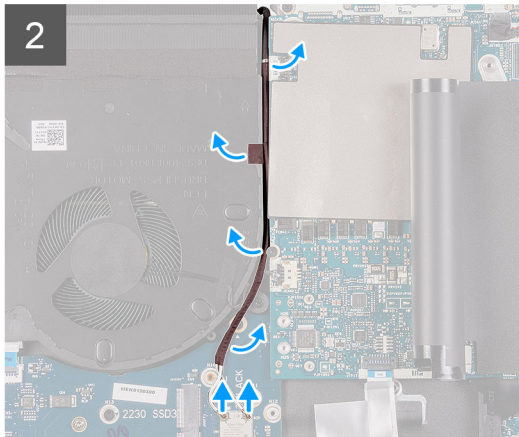
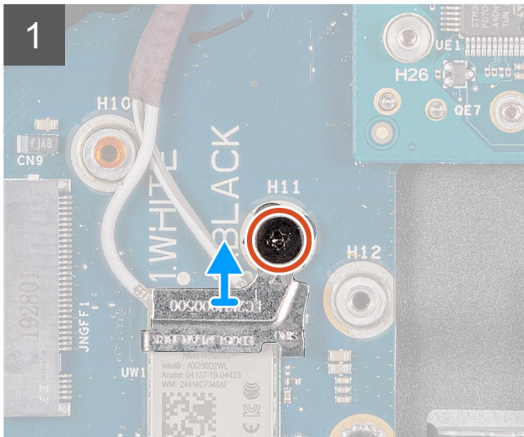
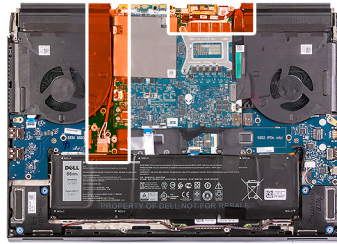



6x
M2.5x5



Steps

1. Remove the screw (M2x3) that secures the wireless card bracket to the left I/O-board.
2. Lift the wireless card bracket off the left I/O-board.
3. Disconnect the antenna cables from the wireless card.
4. Peel the tapes securing the antenna cables to system board and left fan.
5. Remove the antenna cables from the routing guides on the left fan and system board.
6. Peel the tapes securing the display cable to the system board.
7. Open the latch, and disconnect the display cable from the connector on the system board.
8. Disconnect the G-sensor cable from the connector on the system board.
9. Disconnect the Tobii eye tracker cable from the connector on the system board.

 **NOTE:** This step is only applicable to computers shipped with a Tobii eye tracker.

10. Place the computer face up.

 **CAUTION:** Place the computer on a soft and clean surface to avoid scratching the display.

11. Remove the following cables from the routing guides on the palm-rest assembly.
 - Display cable
 - G-sensor cable
 - Tobii eye tracker cable (optional)

- Antenna cables

12. Remove the six screws (M2.5x5) securing the display assembly to the palm-rest assembly.

13. Gently lift the display assembly from the palm-rest assembly.

Installing the display assembly

Prerequisites

If you are replacing a component, remove the existing component before performing the installation procedure.

About this task

CAUTION: Place the computer on a soft and clean surface to avoid scratching the display.

NOTE: The display assembly is a Hinge-Up Display (HUD) and cannot be further disassembled. If components within the display assembly must be replaced, the entire display assembly is to be replaced.

The following image indicates the location of the display assembly and provides a visual representation of the installation procedure.



6x
M2.5x5





1x
M2x3

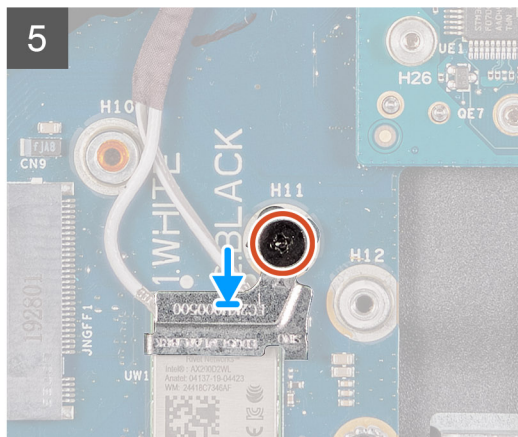
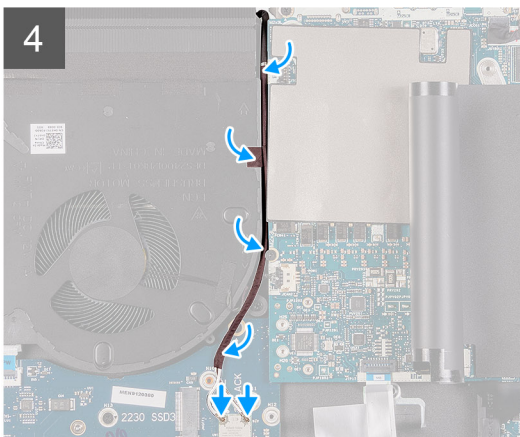
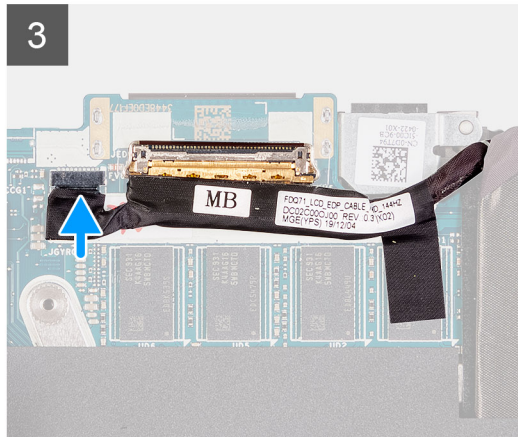
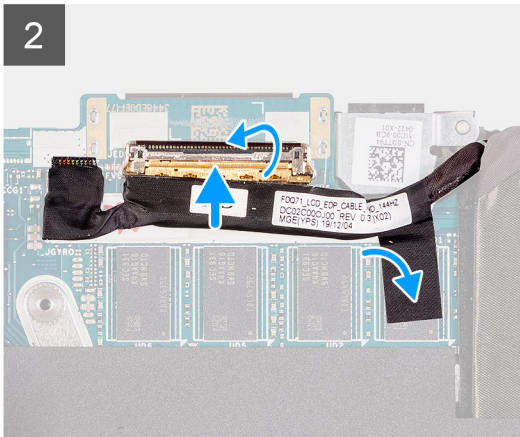
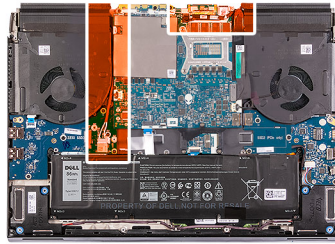

Steps

1. Ensure that the palm-rest assembly is placed face up with the keyboard facing you.
2. Gently place the display assembly on the palm-rest assembly and align the screw holes on the display assembly to the screw holes on the palm-rest assembly.
3. Replace the six screws (M2.5x5) that secure the display assembly to the palm-rest assembly.
4. Route the following cables to the routing guides on the palm-rest assembly.
 - Display cable
 - G-sensor cable
 - Tobii eye tracker cable (optional)
 - Antenna cables
5. Place the computer face down.
6. Connect the Tobii eye tracker cable to the connector on the system board.

i **NOTE:** This step is only applicable to computers shipped with a Tobii eye tracker.
7. Connect the G-sensor cable to the connector on the system board.
8. Connect the display cable to the connector on the system board and close the latch.
9. Route the antenna cables to the routing guides on the left fan and system board.
10. Adhere the tapes that secure the antenna cables to system board and left fan.

11. Connect the antenna cables to the wireless card.

The following table provides the antenna-cable color scheme for the wireless card that is supported by your computer.

Table 2. Antenna-cable color scheme

Connectors on the wireless card	Antenna-cable color
Main (white triangle)	White or Grey
Auxiliary (black triangle)	Black or Orange

12. Place the wireless card bracket on the wireless card.

13. Replace the screw (M2x3) that secures the wireless card bracket to the left I/O-board.

Next steps

1. Install the [rear I/O-cover](#).
2. Install the [base cover](#).
3. Follow the procedure in [After working inside your computer](#).

Right I/O-board

Removing the right I/O-board

Prerequisites

1. Follow the procedure in [Before working inside your computer](#).
2. Remove the [base cover](#).
3. Remove the [battery](#).
4. Remove the [2230 solid-state drive in M.2 slot two](#), if installed.
5. Remove the [2280 solid-state drive in M.2 slot two](#), if installed.

About this task

The following image indicates the location of the right I/O-board and provides a visual representation of the removal procedure.

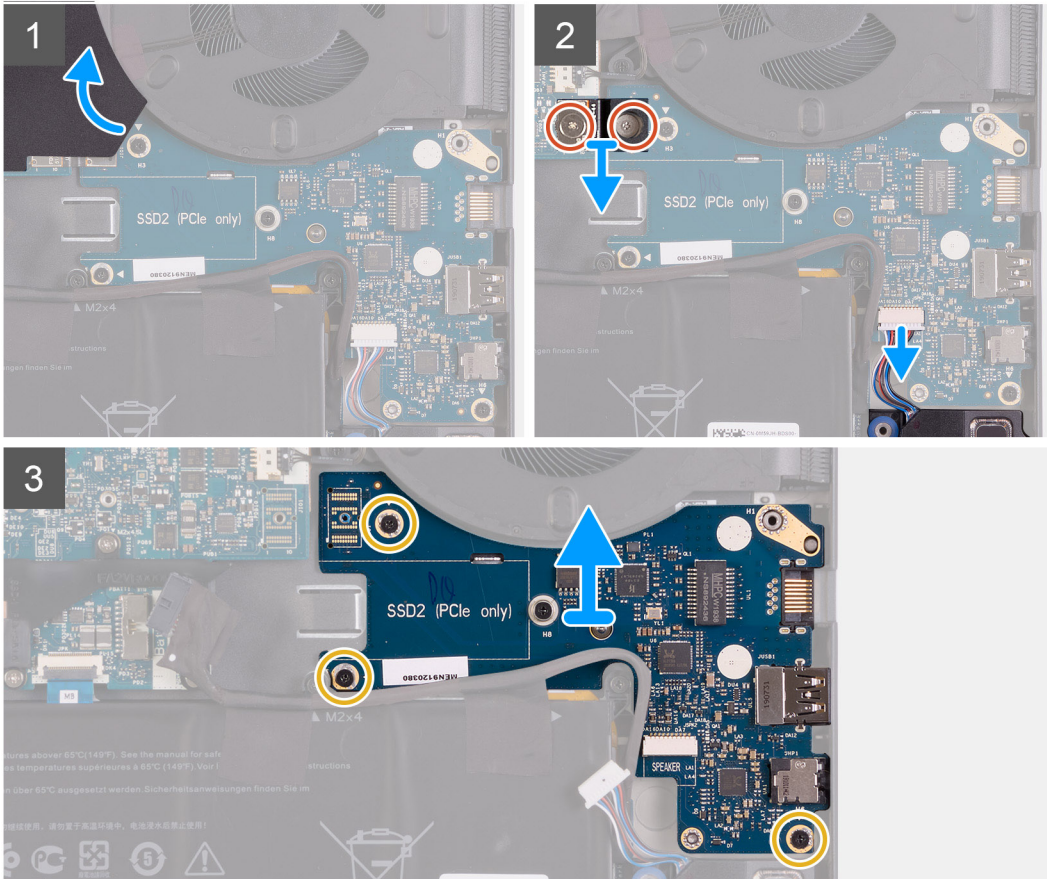

Steps

1. Lift the Mylar that covers the system board and right-I/O board.
2. Remove the two screws (M2x3) that secure the right I/O-board cable connecting the right I/O-board and the system board.
3. Lift the right I/O-board cable off the right I/O-board and system board.
4. Disconnect the speaker cable from the right I/O-board.
5. Remove the three screws (M2x3) that secure the right I/O-board to the palm-rest assembly.
6. Lift the right I/O-board off the palm-rest assembly.

Installing the right I/O-board

Prerequisites

If you are replacing a component, remove the existing component before performing the installation procedure.

About this task

The following image indicates the location of the right I/O-board and provides a visual representation of the installation procedure.

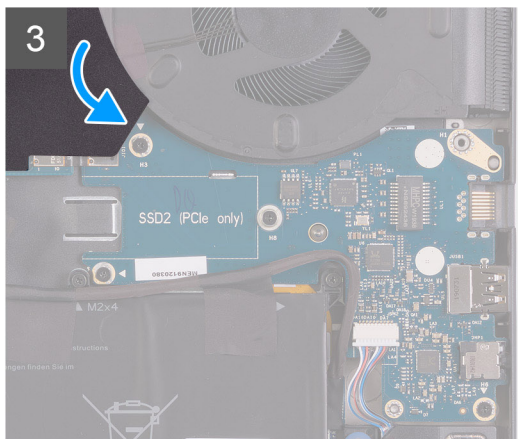
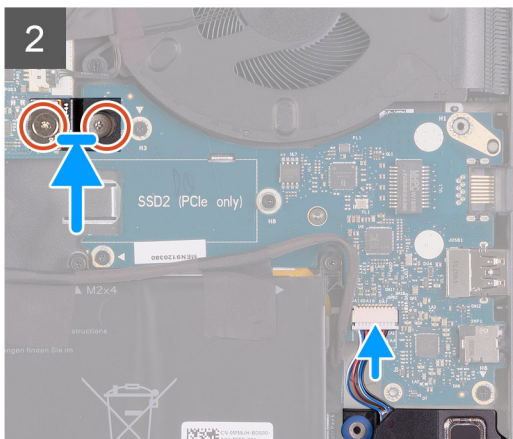
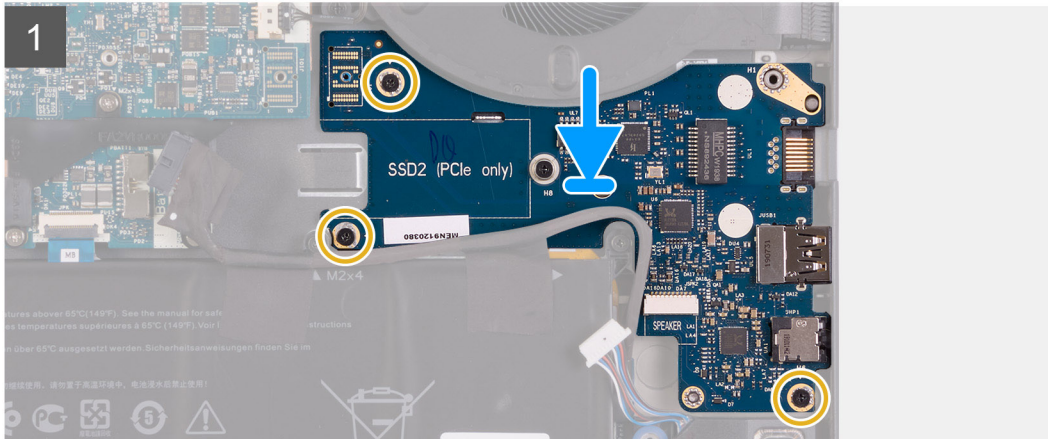

Steps

1. Place the right I/O-board on the palm-rest assembly.
2. Align the screw holes on the right I/O-board with the screw holes on the palm-rest assembly.
3. Replace the three screws (M2x3) that secure the right I/O-board to the palm-rest assembly.
4. Connect the speaker cable to the connector on the right I/O-board.
5. Using the alignment pins, connect the right I/O-board cable on the right I/O-board and the system board.
 - ⓘ **NOTE:** The I/O-board cable is polarity sensitive. To prevent damage to your computer, ensure that the MB UMT end of the cable is connected to the system board.
6. Replace the two screws (M2x3) that secure the right I/O-board cable to the right I/O-board and system board.

Next steps

1. Install the [2280 solid-state drive in M.2 slot two](#), if installed.
2. Install the [2230 solid-state drive in M.2 slot two](#), if installed.
3. Install the [battery](#).
4. Install the [base cover](#).
5. Follow the procedure in [After working inside your computer](#).

System board

Removing the system board

Prerequisites

1. Follow the procedure in [Before working inside your computer](#).
2. Remove the [base cover](#).
3. Remove the [2230 solid-state drive in M.2 slot one](#), if installed.
4. Remove the [2280 solid-state drive in M.2 slot one](#), if installed.
5. Remove the [2230 solid-state drive in M.2 slot two](#), if installed.
6. Remove the [2280 solid-state drive in M.2 slot two](#), if installed.
7. Remove the [rear I/O-cover](#).
8. Remove the [battery](#).

About this task

The following image indicates the location of the system board and provides a visual representation of the removal procedure.

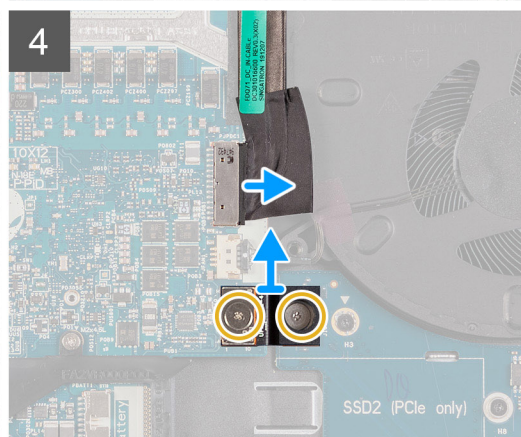
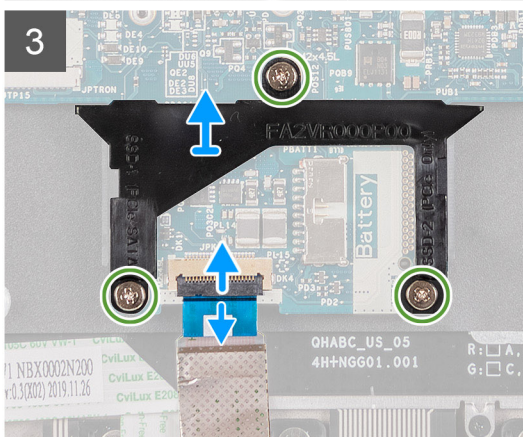
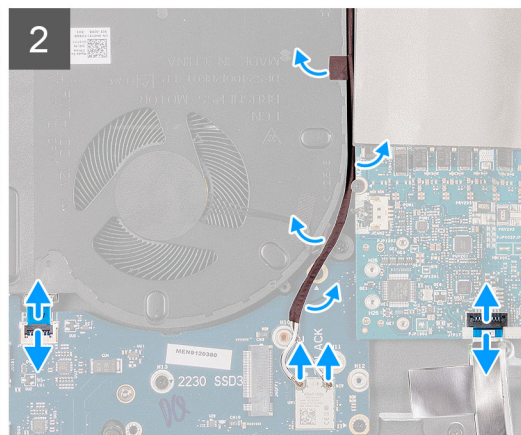
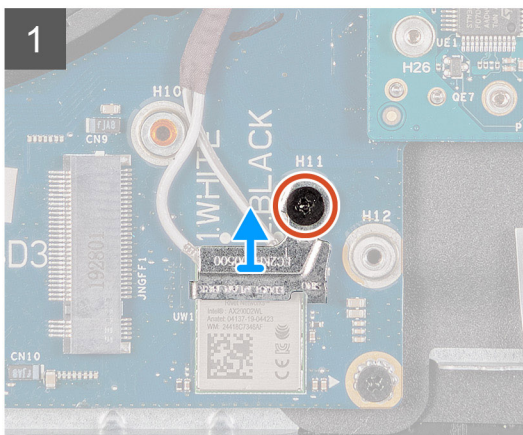
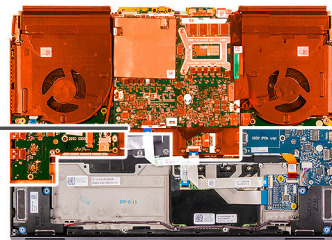



2x
M2.5x5



8x
M2x3

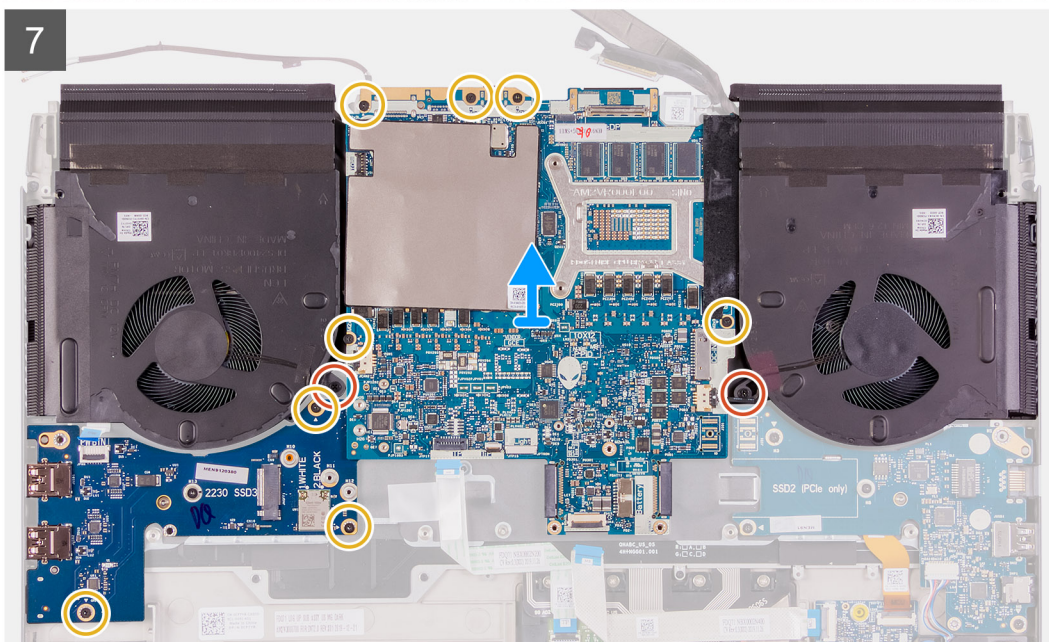
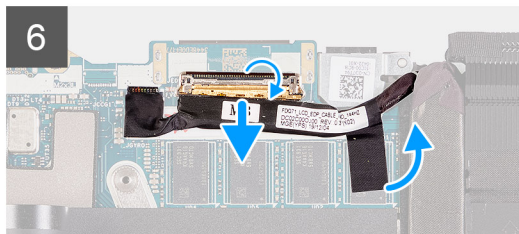
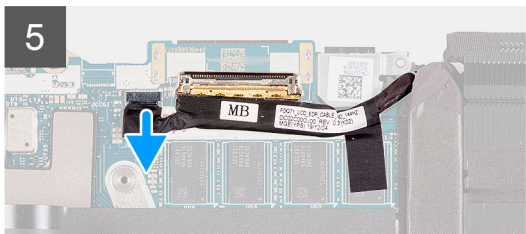

Steps

1. Remove the screw (M2x3) that secures the wireless card bracket to the left I/O-board.
2. Lift the wireless-card bracket off the left I/O-board.
3. Disconnect the antenna cables from the wireless card.
4. Peel the tapes securing the antenna cables to system board and left fan.
5. Remove the antenna cables from the routing guides on the left fan.
6. Open the latch, and disconnect the power-button cable from the left I/O-board.
7. Open the latch, and disconnect the touchpad cable from the system board.
8. Open the latch, and disconnect the keyboard-controller board-cable from the system board.
9. Remove the three screws (M2x4.5) that secure the solid-state drive support bracket to the system board.
10. Remove the solid-state drive support bracket from the system board.
11. Remove the two screws (M2x3) that secure the right I/O-board cable to the right I/O-board and the system board.
12. Lift the right I/O-board cable off the right I/O-board and the system board.
13. Disconnect the power-adaptor port cable from the system board.
14. Open the latch, and disconnect the display cable from the connector on the system board.
15. Disconnect the G-sensor cable from the connector on the system board.
16. Disconnect the Tobii eye tracker cable from the connector on the system board.

i | **NOTE:** This step is only applicable to computers shipped with a Tobii eye tracker.

17. Remove the two (M2.5x5) screws that secure the fans to the palm-rest assembly.
18. Remove the five (M2x3) screws that secure the system board to the palm-rest assembly.
19. Remove the three (M2x3) screws that secure the left I/O-board to the palm-rest assembly.
20. Lift the system board and the left I/O-board out of the palm-rest assembly.

i | **NOTE:** When lifting the system board, hold firmly on the left and right sides of the fan and heat-sink assembly.

△ | **CAUTION:** To avoid damaging your computer, do not support the system board by the left I/O-board when lifting the system board.

21. Turn the system board over.
22. Remove the [left I/O-board](#).
23. Remove the [fan and heat-sink assembly](#).

Installing the system board

Prerequisites

If you are replacing a component, remove the existing component before performing the installation procedure.

About this task

The following image indicates the location of the system board and provides a visual representation of the removal procedure.



2x
M2.5x5



8x
M2x3

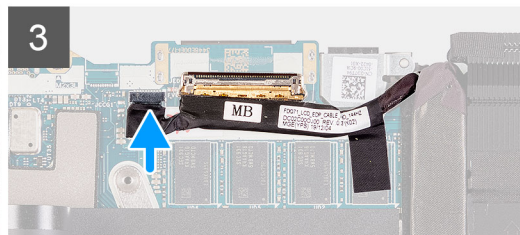
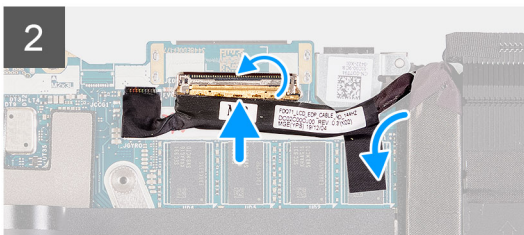
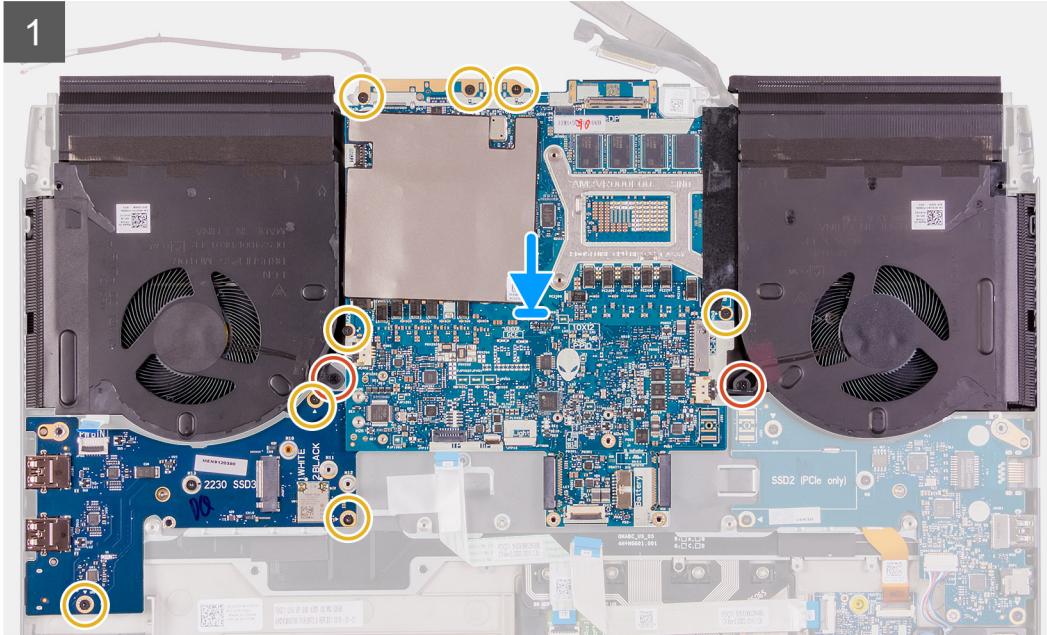
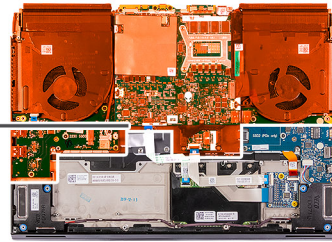

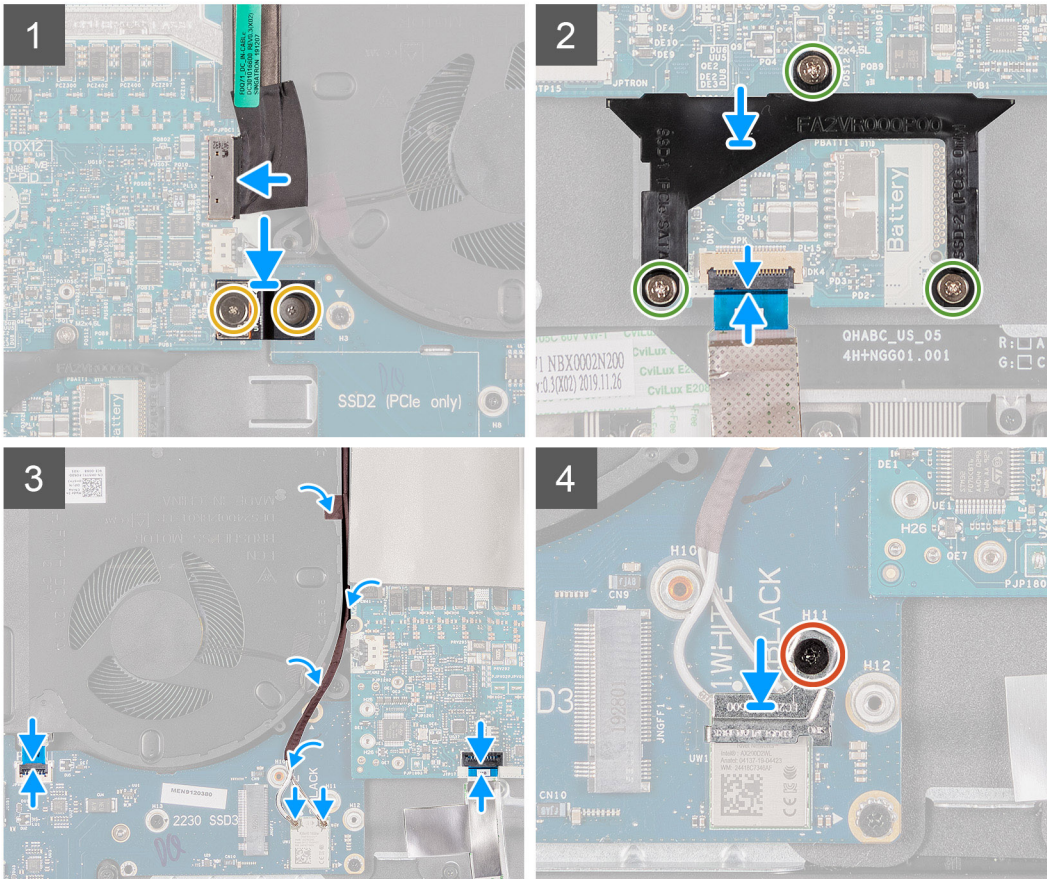

Steps

1. Install the [fan and heat-sink assembly](#).
2. Install the [left I/O-board](#).
3. Turn the system board over, place the system board and the left I/O-board on the palm-rest assembly.

(i) NOTE: When placing the system board in place, hold firmly on the left and right sides of the fan and heat-sink assembly.

△ CAUTION: To avoid damaging your computer, do not support the system board by the left I/O-board when placing the system board.

4. Replace the two (M2.5x5) screws that secure the fans to the palm-rest assembly.
5. Replace the five (M2x3) screws that secure the system board to the palm-rest assembly.
6. Replace the three (M2x3) screws that secure the left I/O-board to the palm-rest assembly.
7. Connect the Tobii eye tracker cable to the connector on the system board.

(i) NOTE: This step is only applicable to computers shipped with a Tobii eye tracker.

8. Connect the G-sensor cable to the connector on the system board.
9. Connect the display cable to the connector on the system board and close the latch.
10. Connect the power-adaptor port cable from the system board.

11. Using the alignment pins, connect the right I/O-board cable to the right I/O-board and the system board.

i **NOTE:** The I/O-board cable is polarity sensitive. To prevent damage to your computer ensure that the MB UMT end of the cable is connected to the system board.

12. Replace the two screws (M2x3) that secure the right I/O-board cable to the right I/O-board and the system board.

13. Using the tab on the solid-state drive support bracket and the slot on the system board, align the screw hole of the solid-state drive support bracket with the screw hole on the system board.

14. Replace the three screws (M2x4.5) that secure the solid-state drive support bracket to the system board.

15. Connect the keyboard-controller board-cable to the system board and close the latch.

16. Connect the touchpad cable to the system board and close the latch.

17. Connect the power-button cable to the system board.

18. Route the antenna cables to the routing guides on the left fan and system board.

19. Adhere the tapes that secure the antenna cables to system board and left fan.

20. Connect the antenna cables to the wireless card.

The following table provides the antenna-cable color scheme for the wireless card that is supported by your computer.

Table 3. Antenna-cable color scheme

Connectors on the wireless card	Antenna-cable color
Main (white triangle)	White or Grey
Auxiliary (black triangle)	Black or Orange

21. Place the wireless card bracket on the wireless card.

22. Replace the screw (M2x3) that secures the wireless card bracket to the left I/O-board.

Next steps

1. Install the [battery](#).
2. Install the [rear I/O-cover](#).
3. Install the [2280 solid-state drive in M.2 slot two](#), if installed.
4. Install the [2230 solid-state drive in M.2 slot two](#), if installed.
5. Install the [2280 solid-state drive in M.2 slot one](#), if installed.
6. Install the [2230 solid-state drive in M.2 slot one](#), if installed.
7. Install the [base cover](#).
8. Follow the procedure in [After working inside your computer](#).

Left I/O-board

Removing the left I/O-board

Prerequisites

1. Follow the procedure in [Before working inside your computer](#).
2. Remove the [base cover](#).
3. Remove the [2230 solid-state drive in M.2 slot one](#), if installed.
4. Remove the [2280 solid-state drive in M.2 slot one](#), if installed.
5. Remove the [2230 solid-state drive in M.2 slot two](#), if installed.
6. Remove the [2280 solid-state drive in M.2 slot two](#), if installed.
7. Remove the [rear I/O-cover](#).
8. Remove the [battery](#).
9. Follow step 1 to step 21 in removing the [system board](#).

About this task

CAUTION: The interposer board is installed between the left I/O-board and system board. Remove the interposer board immediately after removing the left I/O-board and keep it in a clean and safe place. Handle the board by lifting and holding from the edges or the sides as the pins on the interposer board are fragile.

The following image indicates the location of the left I/O-board and provides a visual representation of the removal procedure.



4x
M2x4.5

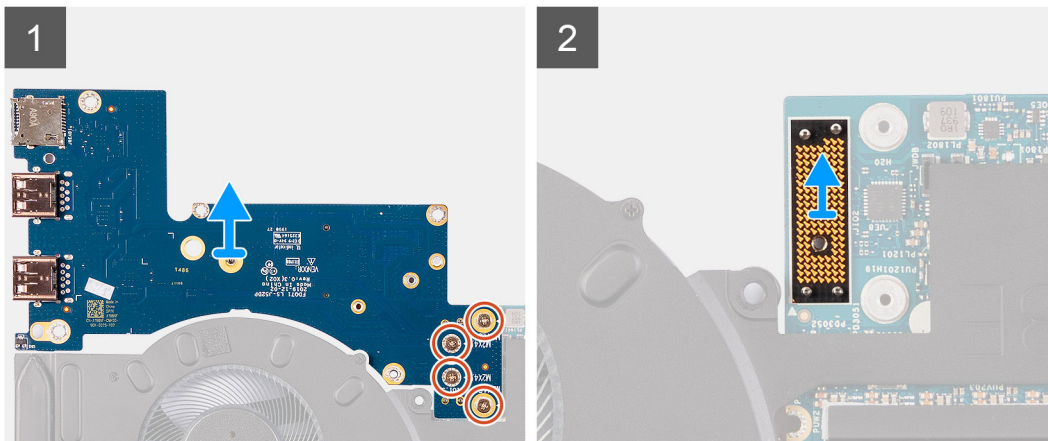
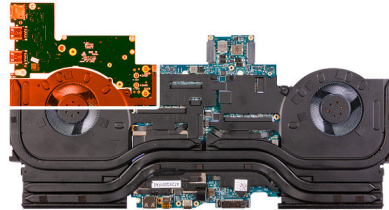

Steps

1. Remove the four screws (M2x4.5) that secure the left I/O-board to the system board.
2. Lift the left I/O-board off the system board.
3. Lift the interposer board off the system board.

NOTE: The interposer may come off with the I/O board.

Installing the left I/O-board

Prerequisites

If you are replacing a component, remove the existing component before performing the installation procedure.

About this task

CAUTION: The interposer board is installed between the left I/O-board and system board. Install the interposer board before installing the left I/O-board. Handle the board by lifting and holding from the edges or the sides as the pins on the interposer board are fragile.

The following image indicates the location of the left I/O-board and provides a visual representation of the installation procedure.



4x
M2x4.5

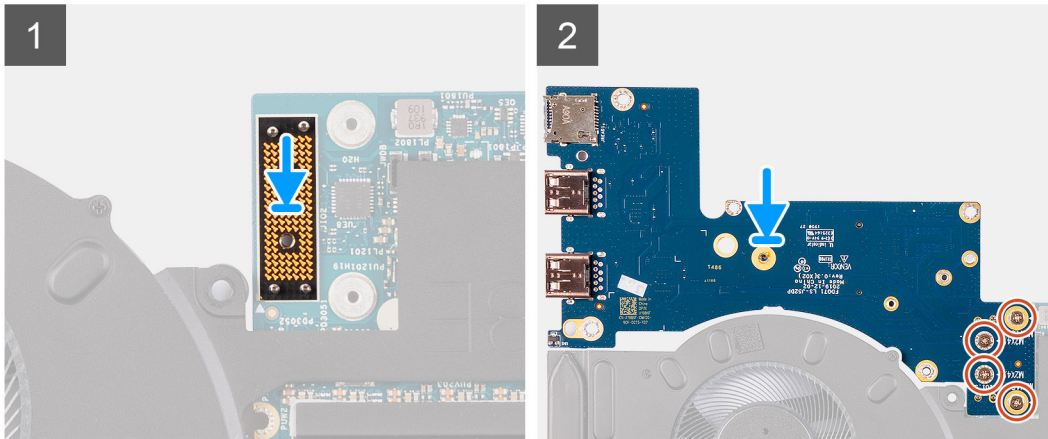
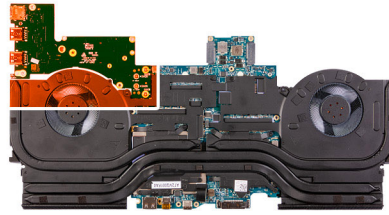

Steps

1. Using the alignment pins, place the interposer board on the system board.
2. Using the alignment pins, connect the left I/O-board to the system board through the interposer board.
3. Align the screw holes on the left I/O-board with the screw holes on the system board and interposer board.
4. Replace the four screws (M2x4.5) that secure the left I/O-board to the system board.

Next steps

1. Follow step 3 to step 22 in installing the [system board](#).
2. Install the [battery](#).
3. Install the [rear I/O-cover](#).
4. Install the [2280 solid-state drive in M.2 slot two](#), if installed.
5. Install the [2230 solid-state drive in M.2 slot two](#), if installed.
6. Install the [2280 solid-state drive in M.2 slot one](#), if installed.
7. Install the [2230 solid-state drive in M.2 slot one](#), if installed.
8. Install the [base cover](#).
9. Follow the procedure in [After working inside your computer](#).

Fan and heat-sink assembly

Removing the fan and heat-sink assembly

Prerequisites

1. Follow the procedure in [Before working inside your computer](#).
2. Remove the [base cover](#).
3. Remove the [2230 solid-state drive in M.2 slot one](#), if installed.
4. Remove the [2280 solid-state drive in M.2 slot one](#), if installed.
5. Remove the [2230 solid-state drive in M.2 slot two](#), if installed.
6. Remove the [2280 solid-state drive in M.2 slot two](#), if installed.
7. Remove the [rear I/O-cover](#).
8. Remove the [battery](#).

9. Follow step 1 to step 21 in removing the [system board](#).

About this task

NOTE: The heat sink may become hot during normal operation. Allow sufficient time for the heat sink to cool before you touch it.

CAUTION: For maximum cooling of the processor, do not touch the heat transfer areas on the heat sink. The oils in your skin can reduce the heat transfer capability of the thermal grease.

The following image indicates the location of the fan and heat-sink assembly and provides a visual representation of the removal procedure.

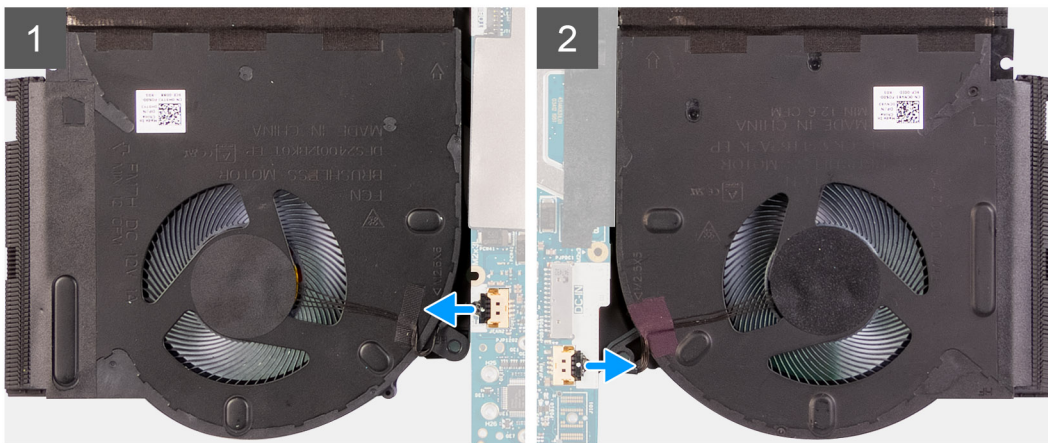
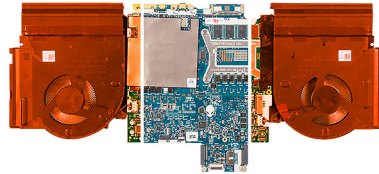



10x
M2x3

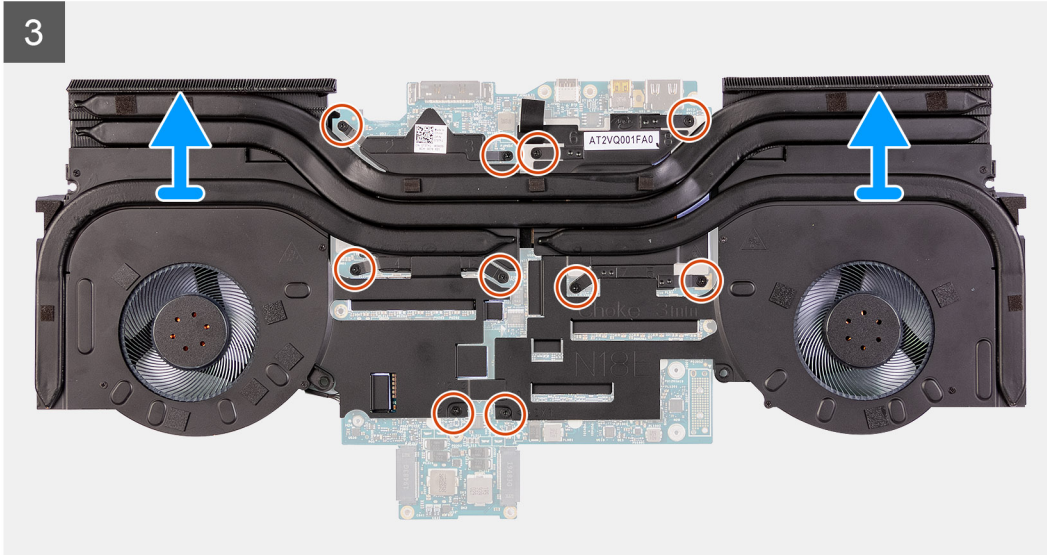
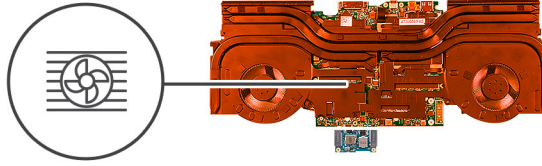

Steps

1. Disconnect the left and right fan cables from the system board.
2. In the reverse sequential order (10>9>8>7>6>5>4>3>2>1), remove the ten screws (M2x3) that secure the fan and heat-sink assembly to the system board.
i | **NOTE:** The number of screws varies depending on the configuration ordered.
3. Using the pull tab, lift the fan and heat-sink assembly from the system board.

Installing the fan and heat-sink assembly

Prerequisites

If you are replacing a component, remove the existing component before performing the installation procedure.

△ | **CAUTION:** If either the processor or the heat sink is replaced, use the thermal grease that is provided in the kit to ensure that the thermal conductivity is achieved.

About this task

The following image indicates the location of the fan and heat-sink assembly and provides a visual representation of the installation procedure.



10x
M2x3

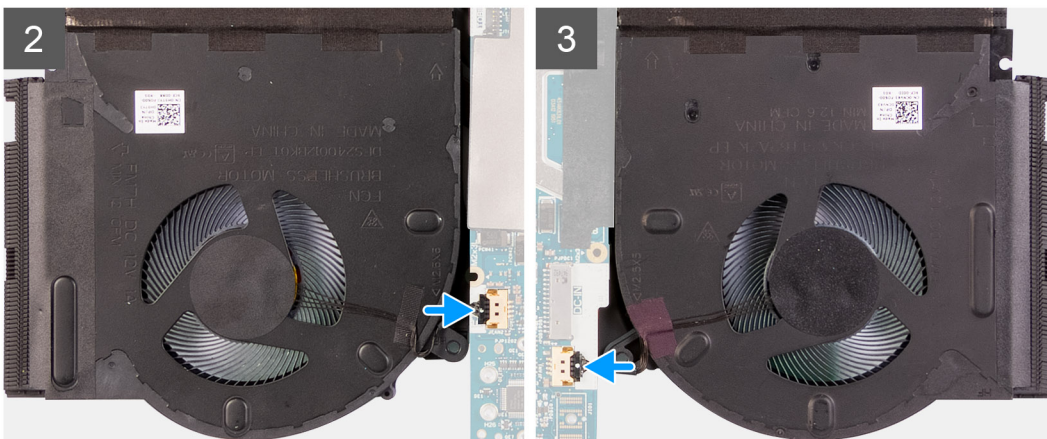
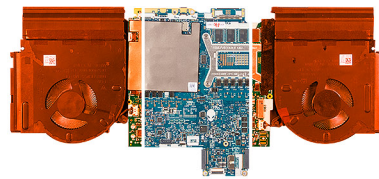
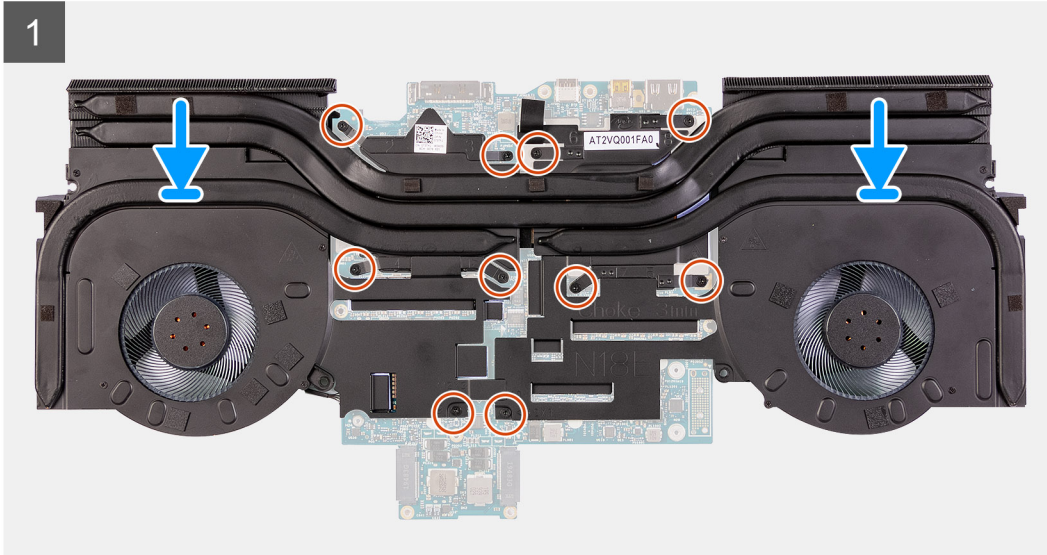
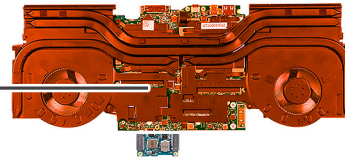

Steps

1. Place the fan and heat-sink assembly on the system board.
2. In sequential order (1>2>3>4>5>6>7>8>9>10), replace the ten screws (M2x3) that secure the fan and heat-sink assembly to the system board.
NOTE: The number of screws varies depending on the configuration ordered.
3. Connect the left and right fan cables to the system board.

Next steps

1. Follow step 3 to step 22 in installing the [system board](#).
2. Install the [battery](#).
3. Install the [rear I/O-cover](#).
4. Install the [2280 solid-state drive in M.2 slot two](#), if installed.
5. Install the [2230 solid-state drive in M.2 slot two](#), if installed.
6. Install the [2280 solid-state drive in M.2 slot one](#), if installed.
7. Install the [2230 solid-state drive in M.2 slot one](#), if installed.
8. Install the [base cover](#).
9. Follow the procedure in [After working inside your computer](#).

Power-adapter port

Removing the power-adapter port

Prerequisites

1. Follow the procedure in [Before working inside your computer](#).
2. Remove the [base cover](#).
3. Remove the [2230 solid-state drive in M.2 slot one](#), if installed.
4. Remove the [2280 solid-state drive in M.2 slot one](#), if installed.
5. Remove the [2230 solid-state drive in M.2 slot two](#), if installed.
6. Remove the [2280 solid-state drive in M.2 slot two](#), if installed.
7. Remove the [rear I/O-cover](#).
8. Remove the [battery](#).
9. Follow step 1 to step 21 in removing the [system board](#).

About this task

The following image indicates the location of the power-adapter port and provides a visual representation of the removal procedure.



2x
M2x3

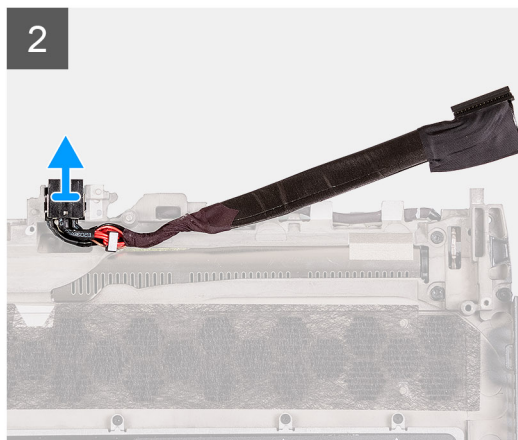
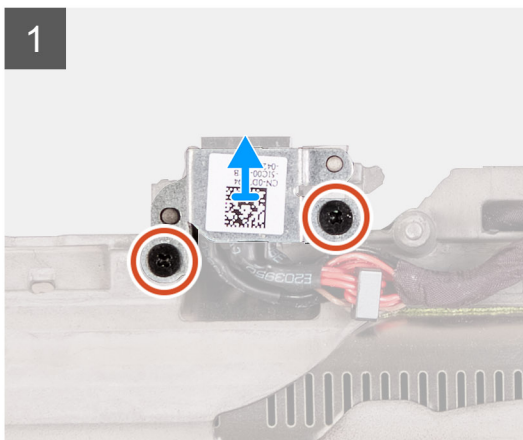
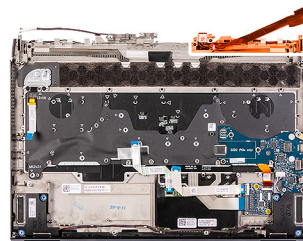

Steps

1. Remove the two screws (M2x3) that secure the power-adapter port bracket to the palm-rest assembly.
2. Lift the power-adapter port bracket off the palm-rest assembly.
3. Lift the power-adapter port along with its cable off the palm-rest assembly.

Installing the power-adapter port

Prerequisites

If you are replacing a component, remove the existing component before performing the installation procedure.

About this task

The following image indicates the location of the power-adapter port and provides a visual representation of the installation procedure.



2x
M2x3

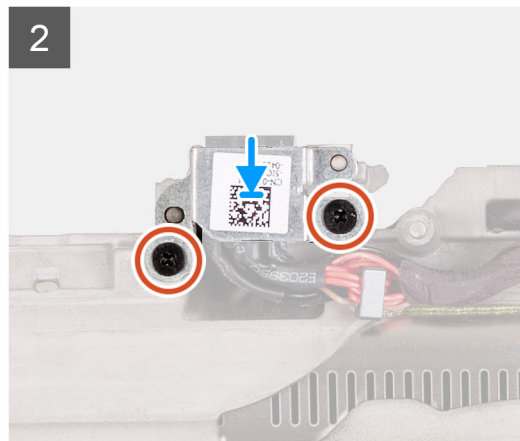
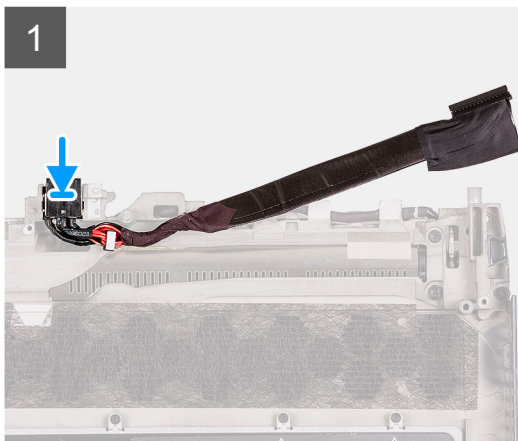
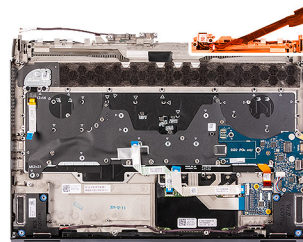

Steps

1. Place the power-adapter port into the slot on the palm-rest assembly.
2. Place the power-adapter port bracket on the power-adapter port.
3. Replace the two screws (M2x3) that secure the power-adapter port bracket to the palm-rest assembly.

Next steps

1. Follow step 3 to step 22 in installing the [system board](#).
2. Install the [battery](#).
3. Install the [rear I/O-cover](#).
4. Install the [2280 solid-state drive in M.2 slot two](#), if installed.
5. Install the [2230 solid-state drive in M.2 slot two](#), if installed.
6. Install the [2280 solid-state drive in M.2 slot one](#), if installed.
7. Install the [2230 solid-state drive in M.2 slot one](#), if installed.
8. Install the [base cover](#).
9. Follow the procedure in [After working inside your computer](#).

Power-button assembly

Removing the power-button assembly

Prerequisites

1. Follow the procedure in [Before working inside your computer](#).
2. Remove the [base cover](#).
3. Remove the [2230 solid-state drive in M.2 slot one](#), if installed.
4. Remove the [2280 solid-state drive in M.2 slot one](#), if installed.
5. Remove the [2230 solid-state drive in M.2 slot two](#), if installed.
6. Remove the [2280 solid-state drive in M.2 slot two](#), if installed.
7. Remove the [rear I/O-cover](#).
8. Remove the [battery](#).
9. Remove the [right I/O-board](#).
10. Follow step 1 to step 21 in removing the [system board](#).

About this task

The following image indicates the location of the power-button assembly and provides a visual representation of the removal procedure.



2x
M2x1.9

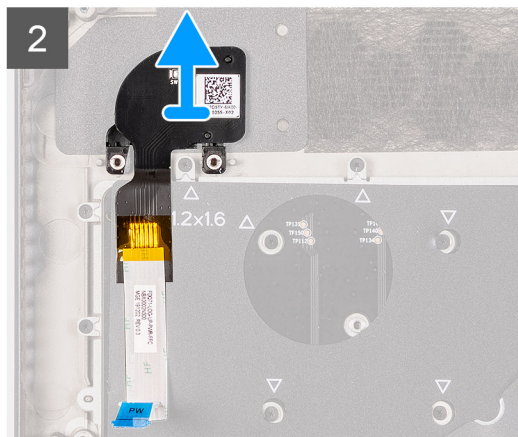
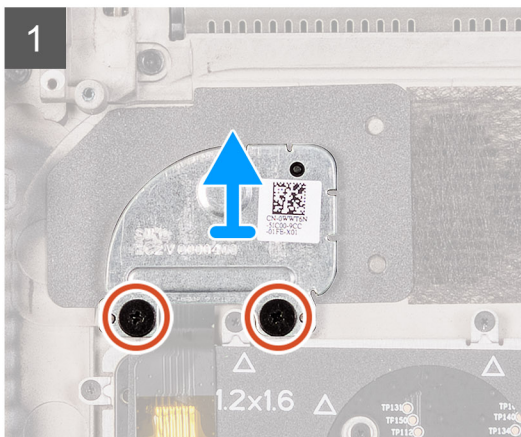
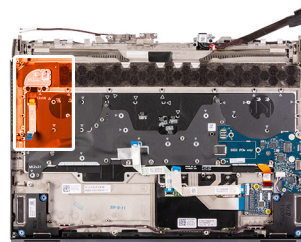

Steps

1. Remove the two (M2x1.9) screws that secure the power-button bracket to the palm-rest assembly.
2. Lift the power-button bracket off the power-button assembly.
3. Peel the power-button assembly and its cable off the palm-rest assembly.

Installing the power-button assembly

Prerequisites

If you are replacing a component, remove the existing component before performing the installation procedure.

About this task

The following image indicates the location of the power-button assembly and provides a visual representation of the installation procedure.



2x
M2x1.9

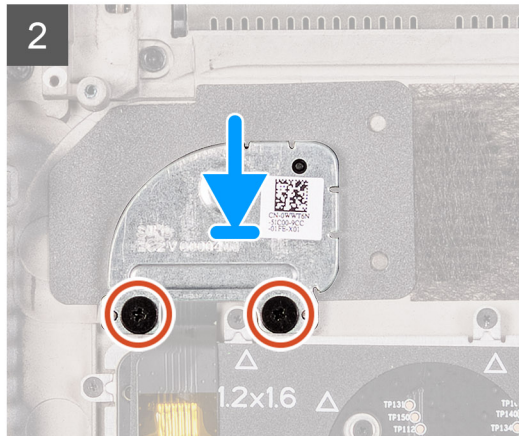
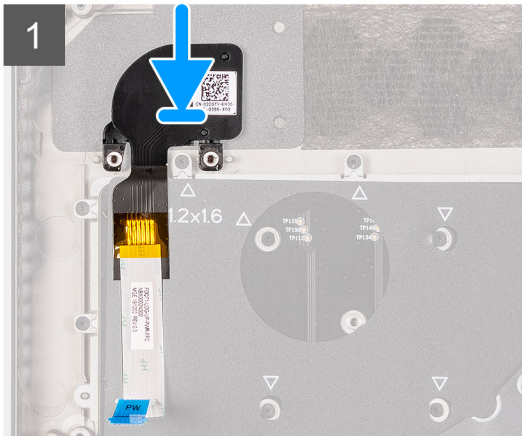
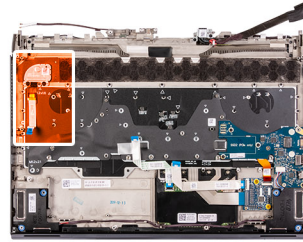

Steps

1. Place the power-button assembly and its cable in the slot on the palm-rest assembly.
2. Place the power-button bracket on the power-button assembly.
3. Replace the two (M2x1.9) screws that secure the power-button bracket to the palm-rest assembly.

Next steps

1. Follow step 3 to step 22 in installing the [system board](#).
2. Install the [right I/O-board](#).
3. Install the [battery](#).
4. Install the [rear I/O-cover](#).
5. Install the [2280 solid-state drive in M.2 slot two](#), if installed.
6. Install the [2230 solid-state drive in M.2 slot two](#), if installed.
7. Install the [2280 solid-state drive in M.2 slot one](#), if installed.
8. Install the [2230 solid-state drive in M.2 slot one](#), if installed.
9. Install the [base cover](#).
10. Follow the procedure in [After working inside your computer](#).

Keyboard

Removing the keyboard

Prerequisites

1. Follow the procedure in [Before working inside your computer](#).
2. Remove the [base cover](#).
3. Remove the [2230 solid-state drive in M.2 slot one](#), if installed.
4. Remove the [2280 solid-state drive in M.2 slot one](#), if installed.

5. Remove the [2230 solid-state drive in M.2 slot two](#), if installed.
6. Remove the [2280 solid-state drive in M.2 slot two](#), if installed.
7. Remove the [rear I/O-cover](#).
8. Remove the [battery](#).
9. Remove the [right I/O-board](#).
10. Follow step 1 to step 21 in removing the [system board](#).

About this task

The following image indicates the location of the keyboard and provides a visual representation of the removal procedure.

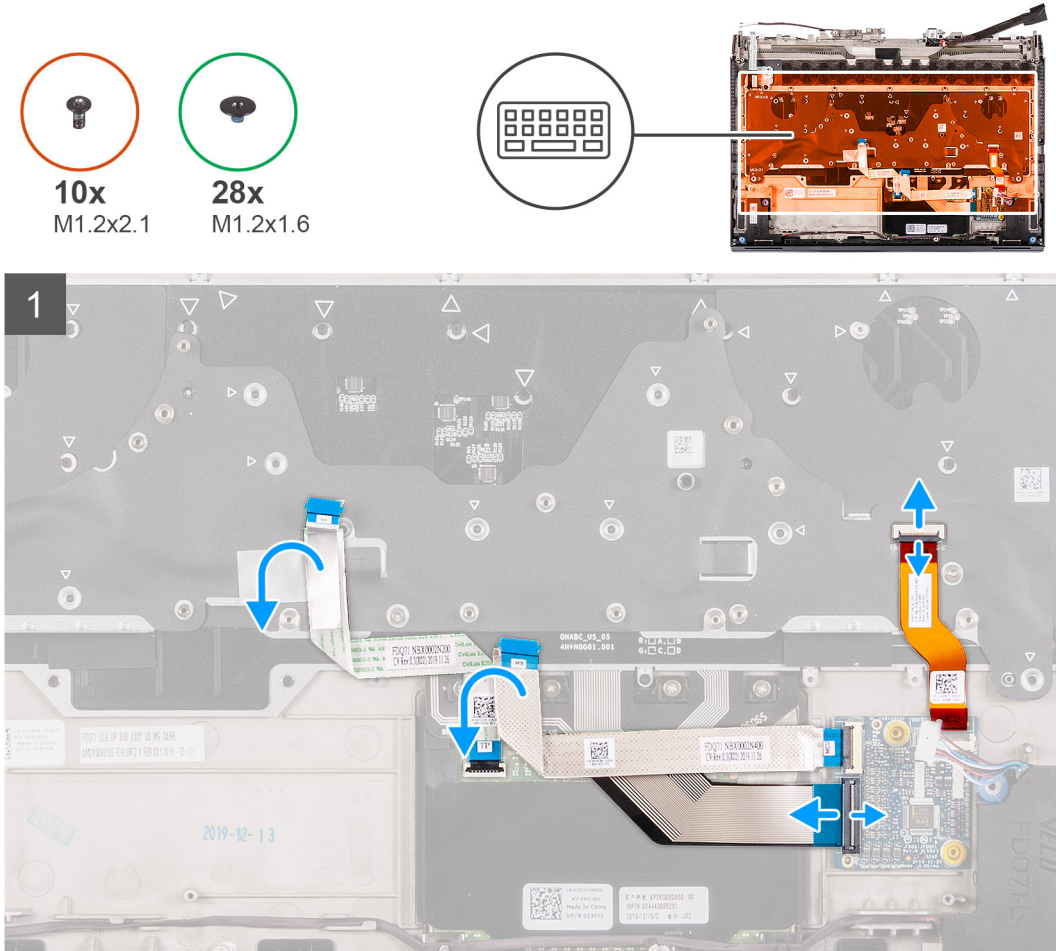

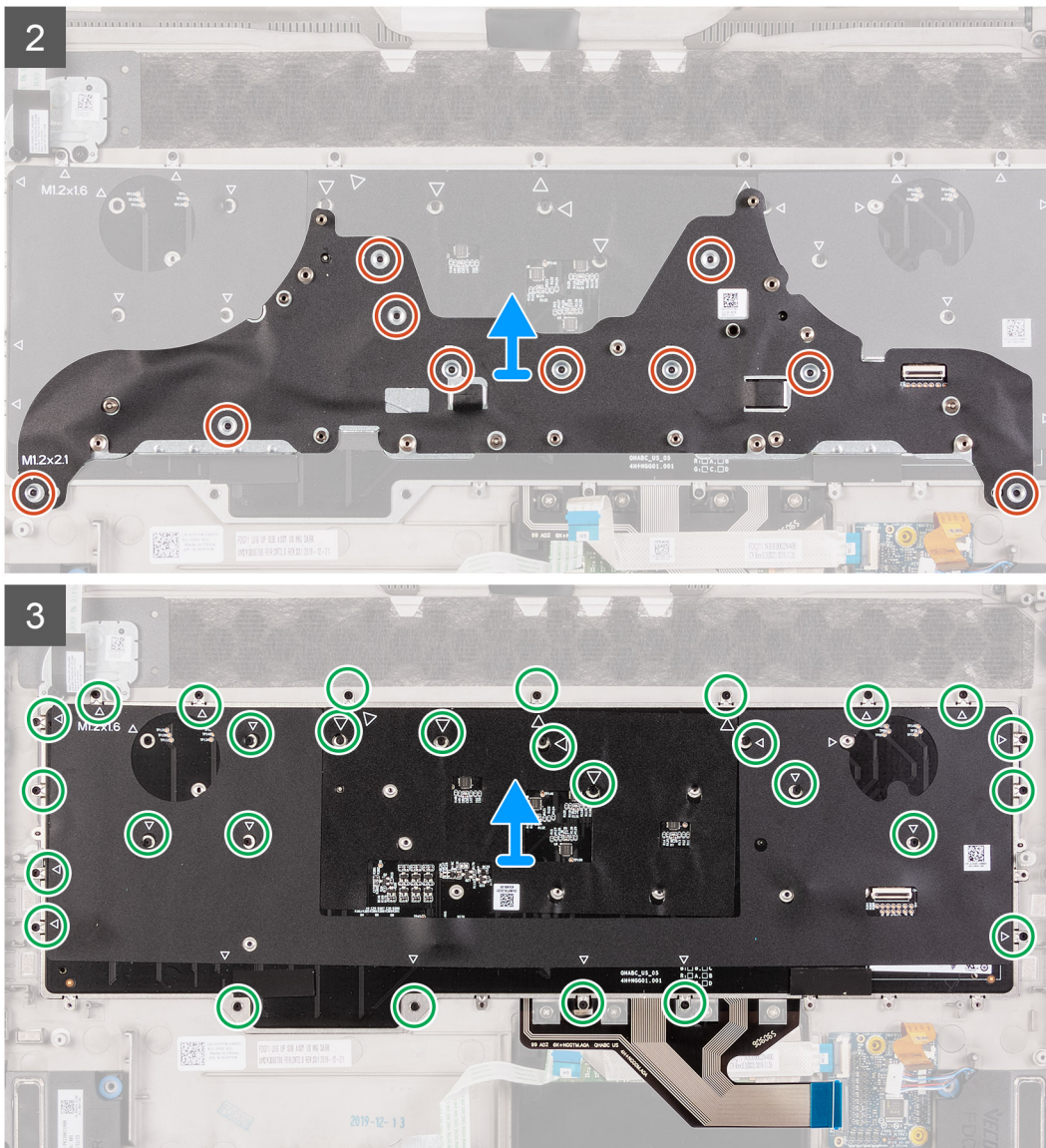

Steps

1. Open the latch, and disconnect the keyboard-backlight cable from the keyboard-controller board.
2. Open the latch, and disconnect the keyboard cable from the keyboard-controller board.
3. Remove the ten (M1.2x2.1) screws that secure the keyboard bracket to the keyboard.
4. Lift the keyboard bracket off the keyboard.
5. Remove the 28 (M1.2x1.6) screws that secure the keyboard to the palm-rest assembly.
6. Lift the keyboard off the palm-rest assembly.

Installing the keyboard

Prerequisites

If you are replacing a component, remove the existing component before performing the installation procedure.

About this task

The following image indicates the location of the keyboard and provides a visual representation of the installation procedure.



10x
M1.2x2.1



28x
M1.2x1.6

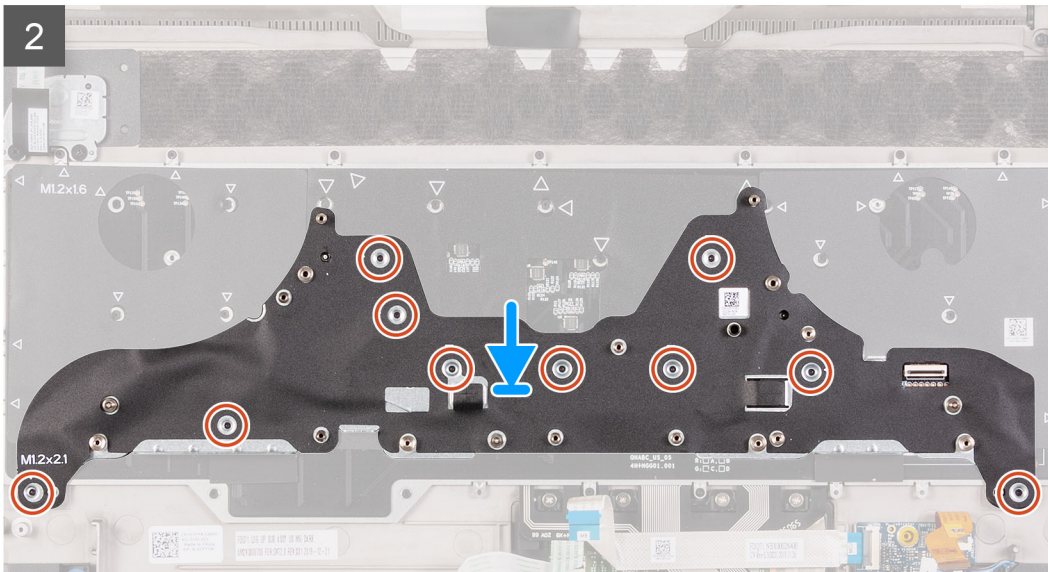
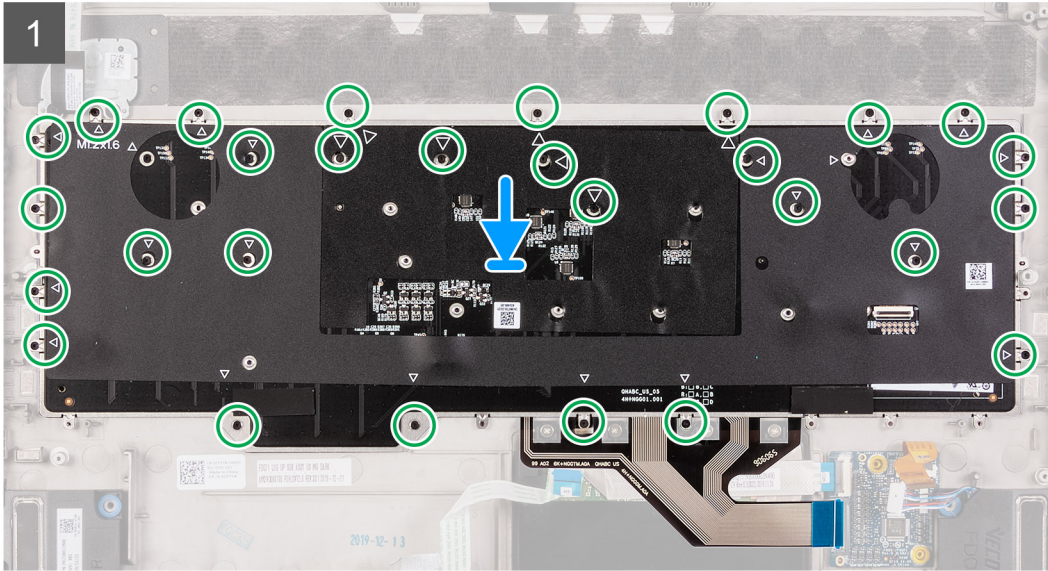
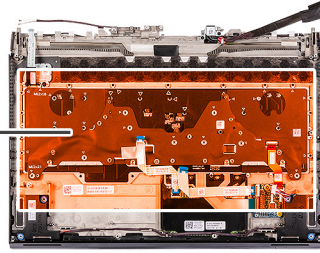

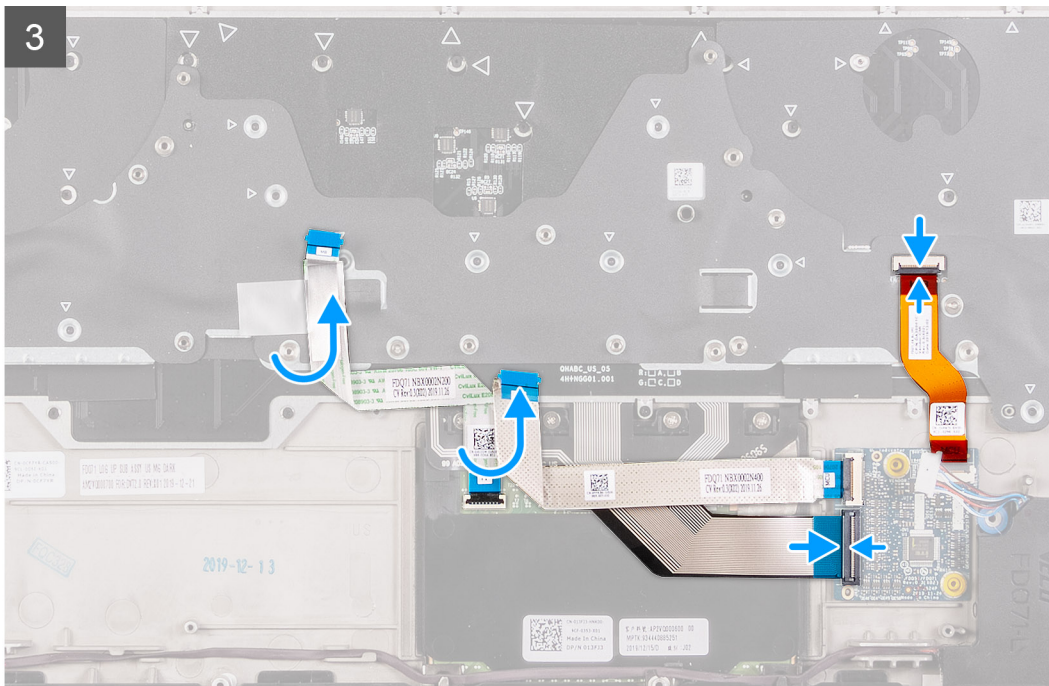

Steps

1. Place the keyboard on the palm-rest assembly.
2. Replace the 28 (M1.2x1.6) screws that secure the keyboard to the palm-rest assembly.
 - ⓘ **NOTE:** The 28 screw holes are marked with an arrow.
3. Place the keyboard bracket on the keyboard.
4. Replace the ten (M1.2x2.1) screws that secure the keyboard bracket to the keyboard.
5. Connect the keyboard cable to the keyboard-controller board and close the latch.
6. Connect the keyboard-backlight cable to the keyboard, and close the latch.

Next steps

1. Follow step 3 to step 22 in installing the [system board](#).
2. Install the [right I/O-board](#).
3. Install the [battery](#).
4. Install the [rear I/O-cover](#).
5. Install the [2280 solid-state drive in M.2 slot two](#), if installed.
6. Install the [2230 solid-state drive in M.2 slot two](#), if installed.
7. Install the [2280 solid-state drive in M.2 slot one](#), if installed.
8. Install the [2230 solid-state drive in M.2 slot one](#), if installed.
9. Install the [base cover](#).
10. Follow the procedure in [After working inside your computer](#).

Removing the mechanical keyboard

Prerequisites

1. Follow the procedure in [Before working inside your computer](#).
2. Remove the [base cover](#).
3. Remove the [2230 solid-state drive in M.2 slot one](#), if installed.
4. Remove the [2280 solid-state drive in M.2 slot one](#), if installed.
5. Remove the [2230 solid-state drive in M.2 slot two](#), if installed.
6. Remove the [2280 solid-state drive in M.2 slot two](#), if installed.
7. Remove the [rear I/O-cover](#).

8. Remove the [battery](#).
9. Remove the [right I/O-board](#).
10. Follow step 1 to step 21 in removing the [system board](#).

About this task

i **NOTE:** This procedure is only applicable for computers shipped with a mechanical keyboard.

The following image indicates the location of the keyboard and provides a visual representation of the removal procedure.

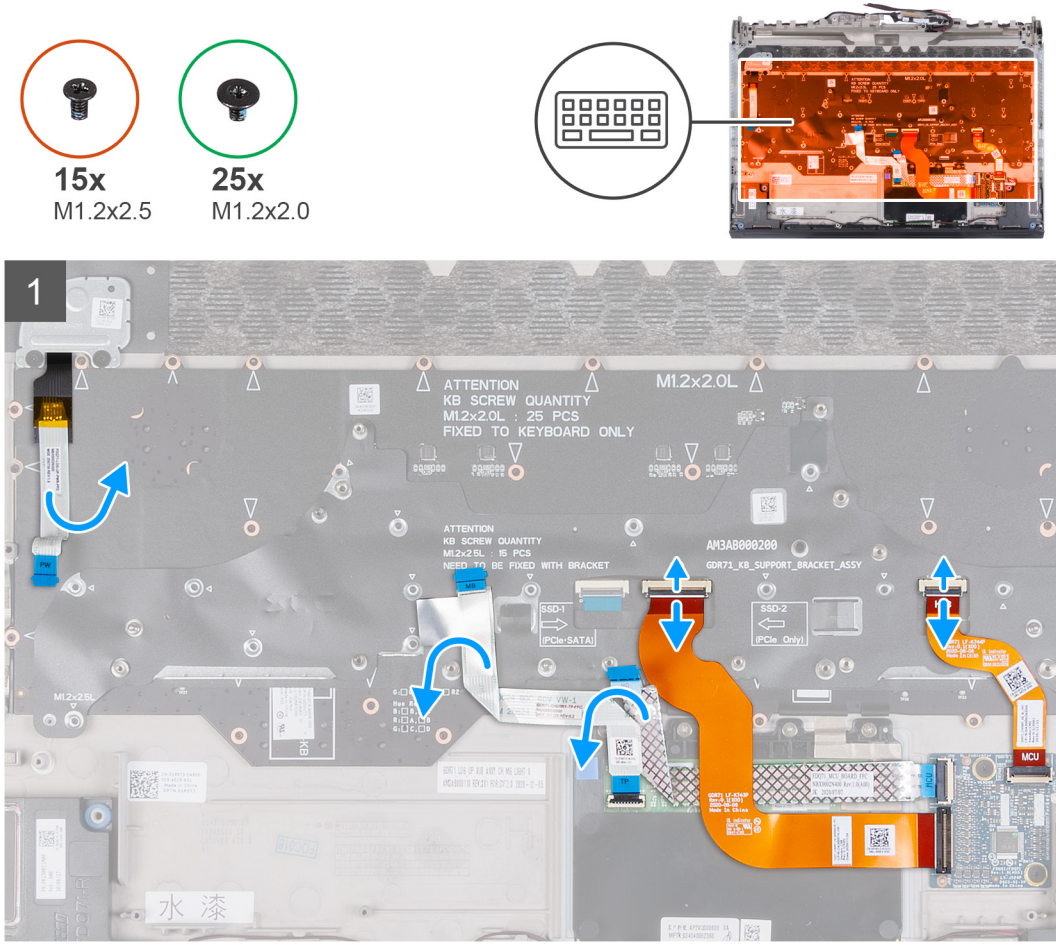

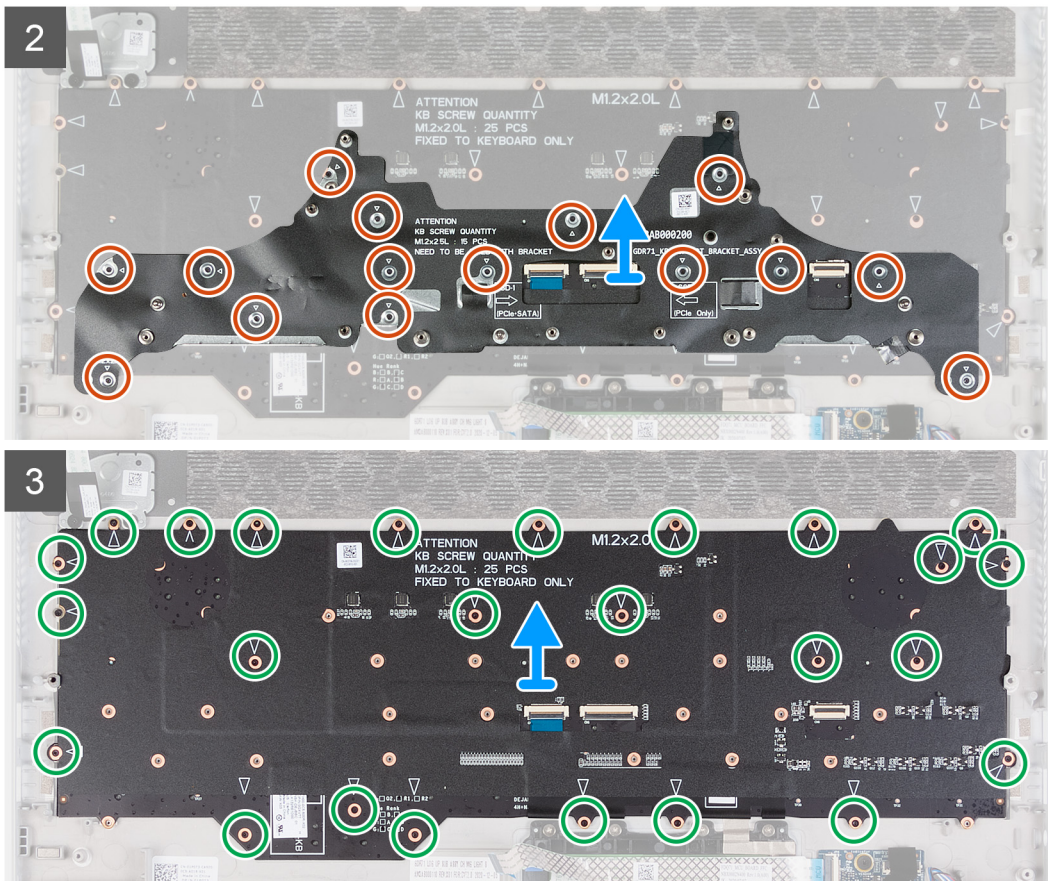

Steps

1. Open the latch, and disconnect the keyboard-backlight cable from the keyboard-controller board.
2. Open the latch, and disconnect the keyboard cable from the keyboard-controller board.
3. Remove the 15 (M1.2x2.5) screws that secure the keyboard bracket to the keyboard.
4. Lift the keyboard bracket off the keyboard.
5. Remove the 25 (M1.2x2) screws that secure the mechanical keyboard to the palm-rest assembly.
 - ⓘ **NOTE:** The 25 screw holes are marked with an arrow.
6. Lift the mechanical keyboard off the palm-rest assembly.

Installing the mechanical keyboard

Prerequisites

If you are replacing a component, remove the existing component before performing the installation procedure.

About this task

ⓘ **NOTE:** This procedure is only applicable if you are installing a mechanical keyboard.

The following image indicates the location of the keyboard and provides a visual representation of the installation procedure.



15x
M1.2x2.5



25x
M1.2x2.0

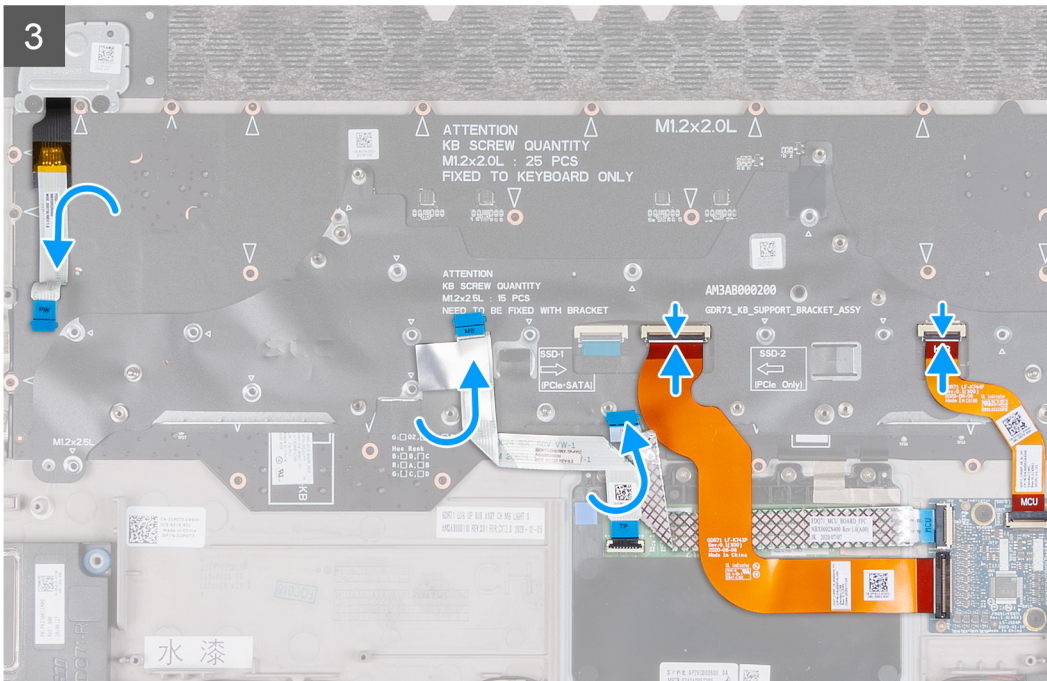
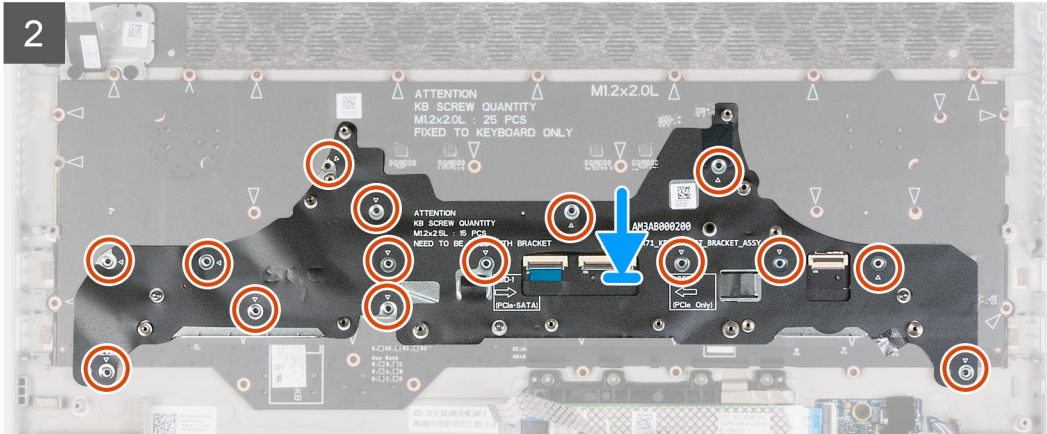
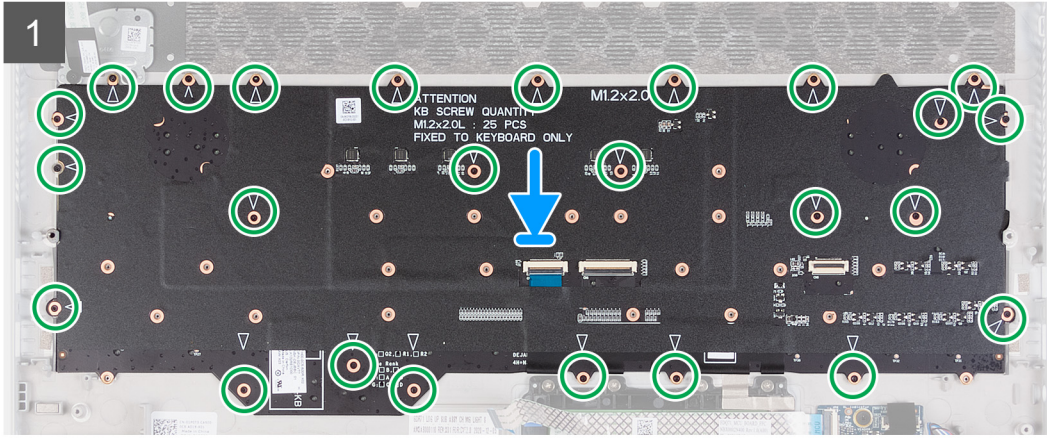

Steps

1. Place the mechanical keyboard on the palm-rest assembly.
2. Replace the 25 (M1.2x2) screws that secure the mechanical keyboard to the palm-rest assembly.
i | **NOTE:** The 25 screw holes are marked with an arrow.
3. Place the keyboard bracket on the keyboard.
4. Replace the 15 (M1.2x2.5) screws that secure the keyboard bracket to the keyboard.
5. Connect the keyboard cable to the keyboard-controller board and close the latch.
6. Connect the keyboard-backlight cable to the keyboard, and close the latch.

Next steps

1. Follow step 3 to step 22 in installing the [system board](#).
2. Install the [right I/O-board](#).
3. Install the [battery](#).
4. Install the [rear I/O-cover](#).
5. Install the [2280 solid-state drive in M.2 slot two](#), if installed.
6. Install the [2230 solid-state drive in M.2 slot two](#), if installed.
7. Install the [2280 solid-state drive in M.2 slot one](#), if installed.
8. Install the [2230 solid-state drive in M.2 slot one](#), if installed.
9. Install the [base cover](#).
10. Follow the procedure in [After working inside your computer](#).

Palmrest

Removing the palm rest

Prerequisites

1. Follow the procedure in [Before working inside your computer](#).
2. Remove the [base cover](#).
3. Remove the [2230 solid-state drive in M.2 slot one](#), if installed.
4. Remove the [2280 solid-state drive in M.2 slot one](#), if installed.
5. Remove the [2230 solid-state drive in M.2 slot two](#), if installed.
6. Remove the [2280 solid-state drive in M.2 slot two](#), if installed.
7. Remove the [speakers](#).
8. Remove the [rear I/O-cover](#).
9. Remove the [battery](#).
10. Remove the [display assembly](#).
11. Remove the [keyboard-controller board](#).
12. Remove the [right I/O-board](#).
13. Follow step 1 to step 21 in removing the [system board](#).
14. Remove the [touchpad](#).
15. Remove the [power-adaptor port](#).
16. Remove the [power-button assembly](#).
17. Remove the [keyboard](#).

Steps

After performing the pre-requisites, you are left with the palm rest.



Installing the palm rest

Prerequisites

If you are replacing a component, remove the existing component before performing the installation procedure.

Steps

To install the palm rest, perform the post-requisites.



Next steps

1. Install the [keyboard](#).

2. Install the [power-button assembly](#).
3. Install the [power-adapter port](#).
4. Install the [touchpad](#).
5. Follow step 3 to step 22 in installing the [system board](#).
6. Install the [right I/O-board](#).
7. Install the [keyboard-controller board](#).
8. Install the [display assembly](#).
9. Install the [battery](#).
10. Install the [rear I/O-cover](#).
11. Install the [speakers](#).
12. Install the [2280 solid-state drive in M.2 slot two](#), if installed.
13. Install the [2230 solid-state drive in M.2 slot two](#), if installed.
14. Install the [2280 solid-state drive in M.2 slot one](#), if installed.
15. Install the [2230 solid-state drive in M.2 slot one](#), if installed.
16. Install the [base cover](#).
17. Follow the procedure in [After working inside your computer](#).

Drivers and downloads

When troubleshooting, downloading or installing drivers it is recommended that you read the Dell Knowledge Based article, Drivers and Downloads FAQ [000123347](#).

System setup

⚠ CAUTION: Unless you are an expert computer user, do not change the settings in the BIOS Setup program. Certain changes can make your computer work incorrectly.

i NOTE: Depending on the computer and its installed devices, the items listed in this section may or may not be displayed.

i NOTE: Before you change BIOS Setup program, it is recommended that you write down the BIOS Setup program screen information for future reference.

Use the BIOS Setup program for the following purposes:

- Get information about the hardware installed in your computer, such as the amount of RAM and the size of the hard drive.
- Change the system configuration information.
- Set or change a user-selectable option, such as the user password, type of hard drive installed, and enabling or disabling base devices.

Entering BIOS setup program

Steps

1. Turn on your computer.
2. Press F2 immediately to enter the BIOS setup program.

i NOTE: If you wait too long and the operating system logo appears, continue to wait until you see the desktop. Then, turn off your computer and try again.

Navigation keys

i NOTE: For most of the System Setup options, changes that you make are recorded but do not take effect until you restart the system.

Table 4. Navigation keys

Keys	Navigation
Up arrow	Moves to the previous field.
Down arrow	Moves to the next field.
Enter	Selects a value in the selected field (if applicable) or follow the link in the field.
Spacebar	Expands or collapses a drop-down list, if applicable.
Tab	Moves to the next focus area. i NOTE: For the standard graphics browser only.
Esc	Moves to the previous page until you view the main screen. Pressing Esc in the main screen displays a message that prompts you to save any unsaved changes and restarts the system.

System setup options

Main

Table 5. Main

Option	Description
System Time	Displays the current time in hh:mm:ss format.
System Date	Displays the current date in mm/dd/yyyy format.
BIOS Version	Displays the BIOS version.
Product Name	Displays the model number of your computer.
Service Tag	Displays the service tag of your computer.
Asset Tag	Displays the asset tag of your computer.
CPU Type	Displays the processor type.
CPU Speed	Displays the processor speed.
CPU ID	Displays the processor identification code.
CPU L1 Cache	Displays the processor L1 cache size.
CPU L2 Cache	Displays the processor L2 cache size.
CPU L3 Cache	Displays the processor L3 cache size.
Integrated Graphics	Displays the integrated graphics.
Discrete Graphics 1	Displays the first discrete graphics that are installed on your computer.
Discrete Graphics 2	Displays the second discrete graphics that are installed on your computer.
M.2 PCIe SSD-1	Displays the type of primary SSD installed.
AC Adapter Type	Displays the AC adapter type.
System Memory	Displays the system memory information.
Memory Speed	Displays the memory speed information.

Advanced

Table 6. Advanced

Option	Description
Chassis Color	Sets the chassis color.
Keyboard Language	Sets the keyboard language.
Keyboard Color	Sets the keyboard color.
Intel SpeedStep	Enables or disables the Intel SpeedStep mode of processor. <ul style="list-style-type: none">• Enable Intel SpeedStep Default: Enabled
Intel Speed Shift Technology	Enables or disables the Intel Speed Shift Technology. This option enables the operating system to select the appropriate processor performance automatically.

Table 6. Advanced (continued)

Option	Description
	<ul style="list-style-type: none"> • Enabled Default: Enabled
Hyper-Thread Control	Allows you to enable or disable the HyperThreading in the processor. <ul style="list-style-type: none"> • Disabled • Enabled Default: Enabled
Integrated NIC	Enables you to configure the onboard LAN controller. <p>Choose one of the following options:</p> <ul style="list-style-type: none"> • Disabled: The internal LAN is off and not visible to the operating system • Enabled: The internal LAN is enabled • Enabled w/PXE: The internal LAN is enabled (with PXE boot) Default: Enabled w/PXE
Power on LID open	Enables or disables the computer to turn on from opening the lid. <p>Default: Enabled</p>
USB Emulation	Enables or disables the USB emulation feature. This feature defines how the BIOS, in the absence of a USB-aware operating system, handles USB devices. USB emulation is always enabled during POST. <p>Default: Enabled</p> <p>(i) NOTE: You cannot boot any type of USB device (floppy, hard drive, or memory key) when this option is off.</p>
USB PowerShare	Enables or disables the USB PowerShare feature. This option enables you to charge external devices using the stored system battery power through the USB PowerShare port when the computer is turned off or in standby mode. <ul style="list-style-type: none"> • Enable USB PowerShare Default: Enabled
USB Wake Support	Enables or disables the USB devices to wake the computer from Standby. <ul style="list-style-type: none"> • Enable USB Wake Support Default: Disabled <p>(i) NOTE: If USB PowerShare is enabled, a device that is connected to the USB PowerShare connector may not wake the computer.</p>
SATA Operation	Enables you to configure the operating mode of the integrated SATA drive controller. <p>Choose one of the following options:</p> <ul style="list-style-type: none"> • Disabled: The SATA controllers are hidden • AHCI: SATA is configured for AHCI mode • RAID On: SATA is configured to support RAID mode

Table 6. Advanced (continued)

Option	Description
	Default: RAID On
Adapter Warnings	Enables or disables the system setup (BIOS) warning messages when you use certain power adapters. <ul style="list-style-type: none"> • Enable Adapter Warnings Default: Enabled
Function Key Behavior	Enables you to set function key or multimedia key as the default function key behavior. Default: Function key
Battery Health	Displays the battery health.
Intel Software Guard Extensions	Enables or disables Intel Software Guard Extensions. Default: Software Controlled
Intel Software Guard Extensions allocated memory size	Displays the allocated memory size for Intel Software Guard Extensions.
Camera	
Thunderbolt	Enables or disables Thunderbolt technology support. The options are: <ul style="list-style-type: none"> • Enabled • Disabled Default: Disabled
Thunderbolt Boot Support	Enables or disables booting from storage devices connected to Thunderbolt port. Default: Disabled

Security

Table 7. Security

Option	Description
Unlock Setup Status	Displays if the setup status is unlocked.
Admin Password Status	Displays if the administrator password is clear or set. Default: Not set
System Password Status	Displays if the system password is clear or set. Default: Not set
Admin Password	Allows you to set, change, or delete the administrator(admin) password. The entries to set password are: <ul style="list-style-type: none"> • Enter the old password: • Enter the new password: • Confirm new password: Click OK once you set the password.

Table 7. Security (continued)

Option	Description
	<p>(i) NOTE: For the first time login, "Enter the old password:" field is marked to "Not set". Hence, password has to be set for the first time you login and then you can change or delete the password.</p>
System Password	<p>Allows you to set, change, or delete the System password.</p> <p>The entries to set password are:</p> <ul style="list-style-type: none"> ● Enter the old password: ● Enter the new password: ● Confirm new password: <p>Click OK once you set the password.</p> <p>(i) NOTE: For the first time login, "Enter the old password:" field is marked to "Not set". Hence, password has to be set for the first time you login and then you can change or delete the password.</p>
Strong Password	<p>Allows you to enforce the option to always set strong password.</p> <ul style="list-style-type: none"> ● Enable Strong Password <p>This option is not set by default.</p>
Password Configuration	<p>You can define the length of your password. Min = 4, Max = 32</p>
Password Bypass	<p>Allows you to bypass the System password and the Internal HDD password, when it is set, during a system restart.</p> <p>Choose one of the options:</p> <ul style="list-style-type: none"> ● Disabled: Always prompt for the system and internal HDD password when they are set. This option is enabled by default.—Default ● Reboot bypass: Bypass the password prompts on Restarts (warm boots).
Password Change	<p>Allows you to change the System password when the administrator password is set.</p> <ul style="list-style-type: none"> ● Allow Non-Admin Password Changes <p>This option is enabled by default.</p>
Non-Admin Setup Changes	<p>Allows you to determine whether changes to the setup options are allowed when an Administrator Password is set. If disabled the setup options are locked by the admin password.</p> <ul style="list-style-type: none"> ● Allow Wireless Switch Changes <p>This option is not set by default.</p>
UEFI Capsule Firmware Updates	<p>Allows you to update the system BIOS via UEFI capsule update packages.</p> <ul style="list-style-type: none"> ● Enable UEFI Capsule Firmware Updates <p>This option is enabled by default.</p>
TPM 2.0 Security	<p>Allows you to enable or disable the Trusted Platform Module (TPM) during POST.</p> <p>The options are:</p> <ul style="list-style-type: none"> ● TPM On—Default ● Clear ● PPI Bypass for Enable Command—Default ● PPI Bypass for Disbale Command ● PPI Bypass for Clear Command ● Attestation Enable—Default ● Key Storage Enable—Default

Table 7. Security (continued)

Option	Description
	<ul style="list-style-type: none"> • SHA-256—Default Choose one of the options: <ul style="list-style-type: none"> • Disbaled • Enabled—Default
TPM Security	Allows you to enable the Trusted Platform Module (TPM) during POST. Default Setting: This option is not set by default.
PPI Bypass for Clear Command	Enables you to control the TPM Physical Presence Interface (PPI). When enabled, this setting will allow the OS to skip BIOS PPI user prompts when issuing the Clear command. Changes to this setting take effect immediately.
Computrace (R)	Allows you to activate or disable the optional Computrace software. The options are: <ul style="list-style-type: none"> • Deactivate • Disable • Activate—Default

Secure boot

Table 8. Secure Boot

Option	Description
Boot List Option	Displays the available boot options. <ul style="list-style-type: none"> • Legacy • UEFI Default: UEFI
File Browser Add Boot Option	Enables you to add the boot options.
File Browser Del Boot Option	Enables you to delete the boot options.
Secure Boot	Enables or disables the Secure Boot Feature. Choose one of the options: <ul style="list-style-type: none"> • Secure Boot Enable • Secure Boot Disable Default: Enabled
Legacy Option ROMs	Enables or disables the Legacy Option ROMs. Default: Disabled
Attempt Legacy Boot	Enables or disables Attempt Legacy Boot. Default: Disabled
Boot Option Priorities	Displays the boot sequence.
Boot Option #1	Displays the available first boot option.
Boot Option #2	Displays the available second boot option.
Boot Option #3	Displays the available third boot option.

Exit

Table 9. Exit

Option	Description
Save Changes and Reset	Enables you to exit system setup and save your changes.
Discard Changes and Reset	Enables you to exit system setup and load previous values for all system setup options.
Restore Defaults	Enables you to restore default values for all system setup options.
Discard Changes	Enables you to load previous values for all system setup options.
Save Changes	Enables you to save the changes for all system setup options.

System and setup password

Table 10. System and setup password

Password type	Description
System password	Password that you must enter to log in to your system.
Setup password	Password that you must enter to access and make changes to the BIOS settings of your computer.

You can create a system password and a setup password to secure your computer.

 **CAUTION: The password features provide a basic level of security for the data on your computer.**

 **CAUTION: Anyone can access the data that is stored on your computer if it is not locked and left unattended.**

 **NOTE:** System and setup password feature is disabled.

Assigning a system setup password

Prerequisites

You can assign a new **System or Admin Password** only when the status is in **Not Set**.

About this task

To enter the system setup, press F12 immediately after a power-on or reboot.

Steps

1. In the **System BIOS** or **System Setup** screen, select **Security** and press Enter.
The **Security** screen is displayed.
2. Select **System/Admin Password** and create a password in the **Enter the new password** field.
Use the following guidelines to assign the system password:
 - A password can have up to 32 characters.
 - The password can contain the numbers 0 through 9.
 - Only lower case letters are valid, upper case letters are not valid.
 - Only the following special characters are valid: Space, ("), (+), (,), (-), (.), (/), (:), ([), (\), (]), (').
3. Type the system password that you entered earlier in the **Confirm new password** field and click **OK**.
4. Press Esc and a message prompt's you to save the changes.
5. Press Y to save the changes.
The computer restarts.

Deleting or changing an existing system setup password

Prerequisites

Ensure that the **Password Status** is Unlocked (in the System Setup) before attempting to delete or change the existing System and/or Setup password. You cannot delete or change an existing System or Setup password, if the **Password Status** is Locked.

About this task

To enter the System Setup, press F12 immediately after a power-on or reboot.

Steps

1. In the **System BIOS** or **System Setup** screen, select **System Security** and press Enter.
The **System Security** screen is displayed.
2. In the **System Security** screen, verify that **Password Status** is **Unlocked**.
3. Select **System Password**, update, or delete the existing system password, and press Enter or Tab.
4. Select **Setup Password**, update, or delete the existing setup password, and press Enter or Tab.
 **NOTE:** If you change the System and/or Setup password, reenter the new password when prompted. If you delete the System and/or Setup password, confirm the deletion when prompted.
5. Press Esc and a message prompts you to save the changes.
6. Press Y to save the changes and exit from System Setup.
The computer restarts.

Clearing CMOS settings

About this task

 **CAUTION:** Clearing CMOS settings will reset the BIOS settings on your computer.

Steps

1. Remove the [base cover](#).
2. Disconnect the battery cable from the system board.
3. Press the power button for 15 seconds.
4. Wait for one minute.
5. Connect the battery cable to the system board.
6. Replace the [base cover](#).

Clearing BIOS (System Setup) and System passwords

About this task

To clear the system or BIOS passwords, contact Dell technical support as described at www.dell.com/contactdell.

 **NOTE:** For information on how to reset Windows or application passwords, refer to the documentation accompanying Windows or your application.

Updating the BIOS

Updating the BIOS in Windows

Steps

1. Go to www.dell.com/support.

2. Click **Product support**. In the **Search support** box, enter the Service Tag of your computer, and then click **Search**.

 **NOTE:** If you do not have the Service Tag, use the SupportAssist feature to automatically identify your computer. You can also use the product ID or manually browse for your computer model.

3. Click **Drivers & Downloads**. Expand **Find drivers**.

4. Select the operating system installed on your computer.

5. In the **Category** drop-down list, select **BIOS**.

6. Select the latest version of BIOS, and click **Download** to download the BIOS file for your computer.

7. After the download is complete, browse the folder where you saved the BIOS update file.

8. Double-click the BIOS update file icon and follow the on-screen instructions.

For more information, see knowledge base article [000124211](https://www.dell.com/support/000124211) at www.dell.com/support.

Updating the BIOS using the USB drive in Windows

Steps

1. Follow the procedure from step 1 to step 6 in [Updating the BIOS in Windows](#) to download the latest BIOS setup program file.

2. Create a bootable USB drive. For more information, see the knowledge base article [000145519](https://www.dell.com/support/000145519) at www.dell.com/support.

3. Copy the BIOS setup program file to the bootable USB drive.

4. Connect the bootable USB drive to the computer that needs the BIOS update.

5. Restart the computer and press **F12**.

6. Select the USB drive from the **One Time Boot Menu**.

7. Type the BIOS setup program filename and press **Enter**.
The **BIOS Update Utility** appears.

8. Follow the on-screen instructions to complete the BIOS update.

Updating the BIOS from the F12 One-Time boot menu

Update your computer BIOS using the BIOS update.exe file that is copied to a FAT32 USB drive and booting from the F12 One-Time boot menu.

About this task

BIOS Update

You can run the BIOS update file from Windows using a bootable USB drive or you can also update the BIOS from the F12 One-Time boot menu on the computer.

Most of the Dell computers built after 2012 have this capability, and you can confirm by booting your computer to the F12 One-Time Boot Menu to see if BIOS FLASH UPDATE is listed as a boot option for your computer. If the option is listed, then the BIOS supports this BIOS update option.

 **NOTE:** Only computers with BIOS Flash Update option in the F12 One-Time boot menu can use this function.

Updating from the One-Time boot menu

To update your BIOS from the F12 One-Time boot menu, you need the following:

- USB drive formatted to the FAT32 file system (key does not have to be bootable)
- BIOS executable file that you downloaded from the Dell Support website and copied to the root of the USB drive
- AC power adapter that is connected to the computer
- Functional computer battery to flash the BIOS

Perform the following steps to perform the BIOS update flash process from the F12 menu:

 **CAUTION: Do not turn off the computer during the BIOS update process. The computer may not boot if you turn off your computer.**

Steps

1. From a turn off state, insert the USB drive where you copied the flash into a USB port of the computer.
2. Turn on the computer and press F12 to access the One-Time Boot Menu, select BIOS Update using the mouse or arrow keys then press Enter.
The flash BIOS menu is displayed.
3. Click **Flash from file**.
4. Select external USB device.
5. Select the file and double-click the flash target file, and then click **Submit**.
6. Click **Update BIOS**. The computer restarts to flash the BIOS.
7. The computer will restart after the BIOS update is completed.

Updating BIOS on systems with BitLocker enabled

△ **CAUTION:** If BitLocker is not suspended before updating the BIOS, the next time you reboot the system it will not recognize the BitLocker key. You will then be prompted to enter the recovery key to progress and the system will ask for this on each reboot. If the recovery key is not known this can result in data loss or an unnecessary operating system re-install. For more information on this subject, see Dell Knowledge Base article: [000134415](https://www.dell.com/support/forums/post?c=2000&lang=en-us&linkid=000134415)

Troubleshooting

Handling swollen Lithium-ion batteries

Like most laptops, Dell laptops use lithium-ion batteries. One type of lithium-ion battery is the lithium-ion polymer battery. Lithium-ion polymer batteries have increased in popularity in recent years and have become standard in the electronics industry due to customer preferences for a slim form factor (especially with newer ultra-thin laptops) and long battery life. Inherent to lithium-ion polymer battery technology is the potential for swelling of the battery cells.

Swollen battery may impact the performance of the laptop. To prevent possible further damage to the device enclosure or internal components leading to malfunction, discontinue the use of the laptop and discharge it by disconnecting the AC adapter and letting the battery drain.

Swollen batteries should not be used and should be replaced and disposed of properly. We recommend contacting Dell product support for options to replace a swollen battery under the terms of the applicable warranty or service contract, including options for replacement by a Dell authorized service technician.

The guidelines for handling and replacing Lithium-ion batteries are as follows:

- Exercise caution when handling Lithium-ion batteries.
- Discharge the battery before removing it from the system. To discharge the battery, unplug the AC adapter from the system and operate the system only on battery power. When the system will no longer power on when the power button is pressed, the battery is fully discharged.
- Do not crush, drop, mutilate, or penetrate the battery with foreign objects.
- Do not expose the battery to high temperatures, or disassemble battery packs and cells.
- Do not apply pressure to the surface of the battery.
- Do not bend the battery.
- Do not use tools of any type to pry on or against the battery.
- If a battery gets stuck in a device as a result of swelling, do not try to free it as puncturing, bending, or crushing a battery can be dangerous.
- Do not attempt to reassemble a damaged or swollen battery into a laptop.
- Swollen batteries that are covered under warranty should be returned to Dell in an approved shipping container (provided by Dell)—this is to comply with transportation regulations. Swollen batteries that are not covered under warranty should be disposed of at an approved recycling center. Contact Dell product support at <https://www.dell.com/support> for assistance and further instructions.
- Using a non-Dell or incompatible battery may increase the risk of fire or explosion. Replace the battery only with a compatible battery purchased from Dell that is designed to work with your Dell computer. Do not use a battery from other computers with your computer. Always purchase genuine batteries from <https://www.dell.com> or otherwise directly from Dell.

Lithium-ion batteries can swell for various reasons such as age, number of charge cycles, or exposure to high heat. For more information on how to improve the performance and lifespan of the laptop battery and to minimize the possibility of occurrence of the issue, see [Dell Laptop Battery - Frequently Asked Questions](#).

System-diagnostic lights

Power and battery-status light

The power and battery status light indicates the power and battery status of the computer. These are the power states:

Solid white:Power adapter is connected and the battery has more than 5% charge.

Amber:Computer is running on battery and the battery has less than 5% charge.

Off:

- Power adapter is connected, and the battery is fully charged.
- Computer is running on battery, and the battery has more than 5% charge.
- Computer is in sleep state, hibernation, or turned off.

The power and battery-status light may also blink red or blue according to pre-defined "beep codes" indicating various failures.

For example, the power and battery-status light blinks red two times followed by a pause, and then blinks blue three times followed by a pause. This 2,3 pattern continues until the computer is turned off, indicating no memory or RAM is detected.

The following table shows different power and battery-status light patterns and associated problems.

i **NOTE:** The following diagnostic light codes and recommended solutions are intended for Dell service technicians to troubleshoot problems. You should only perform troubleshooting and repairs as authorized or directed by the Dell technical assistance team. Damage due to servicing that is not authorized by Dell is not covered by your warranty.

Table 11. Diagnostic-light LED codes

Diagnostic light codes (Red, Blue)	Problem description
2,1	Processor failure
2,2	System board: BIOS or ROM (Read-Only Memory) failure
2,3	No memory or RAM (Random-Access Memory) detected
2,4	Memory or RAM (Random-Access Memory) failure
2,5	Invalid memory installed
2,6	System-board or chipset error
2,7	Display failure - SBIOS message
3,1	Coin-cell battery failure
3,2	PCI, video card/chip failure
3,3	Recovery image not found
3,4	Recovery image found but invalid
3,5	Power-rail failure
3,6	System BIOS Flash incomplete
3,7	Management Engine (ME) error

SupportAssist diagnostics

About this task

The SupportAssist diagnostics (previously known as ePSA diagnostics) performs a complete check of your hardware. The SupportAssist diagnostics is embedded in the BIOS and is launched by it internally. The SupportAssist diagnostics provides a set of options for particular devices or device groups. It allows you to:

- Run tests automatically or in an interactive mode.
- Repeat tests
- Display or save test results
- Run thorough tests to introduce additional test options and provide extra information about the failed device(s)
- View status messages that indicate if the tests are completed successfully
- View error messages that indicate if problems were encountered during the test

i **NOTE:** Some tests are meant for specific devices and require user interaction. Ensure that you are present in front of the computer when the diagnostic tests are performed.

For more information, see [SupportAssist Pre-Boot System Performance Check](#).

Recovering the operating system

When your computer is unable to boot to the operating system even after repeated attempts, it automatically starts Dell SupportAssist OS Recovery.

Dell SupportAssist OS Recovery is a standalone tool that is preinstalled in all Dell computers installed with Windows operating system. It consists of tools to diagnose and troubleshoot issues that may occur before your computer boots to the operating system. It enables you to diagnose hardware issues, repair your computer, back up your files, or restore your computer to its factory state.

You can also download it from the Dell Support website to troubleshoot and fix your computer when it fails to boot into their primary operating system due to software or hardware failures.

For more information about the Dell SupportAssist OS Recovery, see *Dell SupportAssist OS Recovery User's Guide* at www.dell.com/serviceabilitytools. Click **SupportAssist** and then, click **SupportAssist OS Recovery**.

Backup media and recovery options

It is recommended to create a recovery drive to troubleshoot and fix problems that may occur with Windows. Dell proposes multiple options for recovering Windows operating system on your Dell PC. For more information, see [Dell Windows Backup Media and Recovery Options](#).

WiFi power cycle

About this task

If your computer is unable to access the internet due to WiFi connectivity issues a WiFi power cycle procedure may be performed. The following procedure provides the instructions on how to conduct a WiFi power cycle:

 **NOTE:** Some ISPs (Internet Service Providers) provide a modem/router combo device.

Steps

1. Turn off your computer.
2. Turn off the modem.
3. Turn off the wireless router.
4. Wait for 30 seconds.
5. Turn on the wireless router.
6. Turn on the modem.
7. Turn on your computer.

Drain residual flea power (perform hard reset)

About this task

Flea power is the residual static electricity that remains in the computer even after it has been powered off and the battery is removed.

For your safety, and to protect the sensitive electronic components in your computer, you are requested to drain residual flea power before removing or replacing any components in your computer.

Draining residual flea power, also known as a performing a "hard reset", is also a common troubleshooting step if your computer does not power on or boot into the operating system.

To drain residual flea power (perform a hard reset)

Steps

1. Turn off your computer.
2. Disconnect the power adapter from your computer.
3. Remove the base cover.
4. Remove the battery.
5. Press and hold the power button for 20 seconds to drain the flea power.
6. Install the battery.
7. Install the base cover.

8. Connect the power adapter to your computer.

9. Turn on your computer.



 **NOTE:** For more information about performing a hard reset, see the knowledge base article [000130881](https://www.dell.com/support) at www.dell.com/support.

Getting help and contacting Alienware

Self-help resources

You can get information and help on Alienware products and services using these online self-help resources:

Table 12. Alienware products and online self-help resources

Self-help resources	Resource location
Information about Alienware products and services	www.alienware.com
My Dell app	
Tips	
Contact Support	In Windows search, type Contact Support , and press Enter .
Online help for operating system	www.dell.com/support/windows
Access top solutions, diagnostics, drivers and downloads, and learn more about your computer through videos, manuals and documents.	Your Alienware computer is uniquely identified by a Service Tag or Express Service Code. To view relevant support resources for your Dell computer, enter the Service Tag or Express Service Code at www.dell.com/support . For more information on how to find the Service Tag for your computer, see Locate the Service Tag on your computer .
VR Support	www.dell.com/VRsupport
Videos providing step-by-step instructions to service your computer	www.youtube.com/alienwareservices

Contacting Alienware

To contact Alienware for sales, technical support, or customer service issues, see www.alienware.com.

- ① **NOTE:** Availability varies by country/region and product, and some services may not be available in your country/region.
- ① **NOTE:** If you do not have an active Internet connection, you can find contact information about your purchase invoice, packing slip, bill, or Dell product catalog.